

Wallbox eMH1

Installation manual and charging procedure

LANGUAGES

English

4



FURTHER LANGUAGES

[www.abl.de / Service / Downloads](http://www.abl.de/Service/Downloads)

3

**Congratulations
on your new eMH1 Wallbox!**

Your eMH1 is compact.

It's easy to use.

With a maximum of safety.

CONTENTS

Safety first

1. Safety and user information	8
--------------------------------	---

Introduction

2. Your model variant	18
3. Components included	20
4. Accessories	21

Mechanical installation

5. Preparing for mechanical installation	26
6. Fixing points	28
7. Power supply entry	31
8. Mounting	34

Electrical installation

9. Preparing for electrical installation	40
10. homeCLU	43
11. Electrical installation	51
12. Start-up	58

Charging procedure

13. Charging	64
--------------	----

Appendix

14. Definitions	80
15. Specifications	81
16. Standards, guidelines and trademarks	86
17. Warranty and guarantee provisions	89
18. Disposal advice	91

SAFETY FIRST

1. Safety and user information

8

1. SAFETY AND USER INFORMATION



- Please observe all safety and user information
- Relevant local regulations for operating electrical devices always apply.



Indicates

- Dangerous electrical currents
- Dangers to life and limb



Indicates

- Risks arising from damage to the device
- Risks for other users



Indicates

- important information and particularities

1. SAFETY AND USER INFORMATION

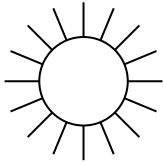

The Wallbox must not be exposed to direct sunlight



The installation site must offer protection against rain and running water or other liquids

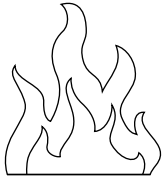

The Wallbox is not situated near a heat source

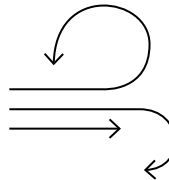

The installation site must offer sufficient air circulation.
Operating temperature:
p. 81

1. SAFETY AND USER INFORMATION

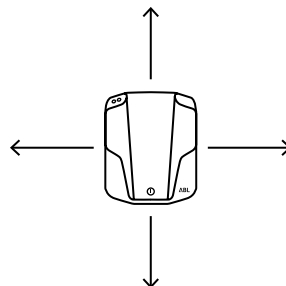
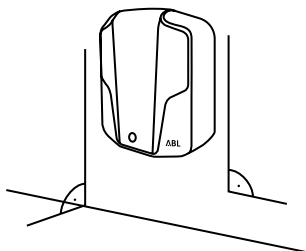
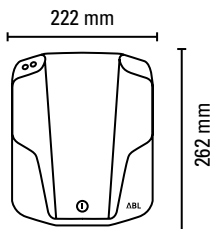

- The installation surface measures at least 262 x 222 mm (height x width)

- The mounting substrate must be level and firm

- Minimum distances to other technical installations must be observed

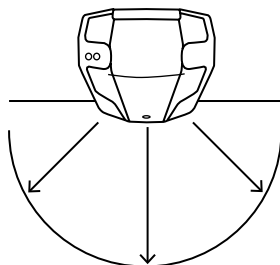
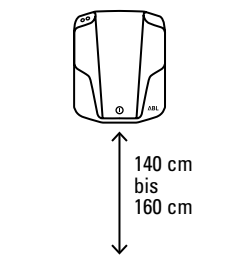

- The installation height is between 140 and 160 cm (floor to bottom edge of housing)

- The installation site must be freely accessible

- If unsure, please contact your specialist electrical contractor

1. SAFETY AND USER INFORMATION

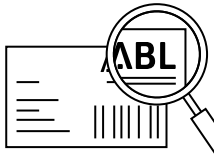

- The rated voltage must be observed.
Rated voltage: p. 81

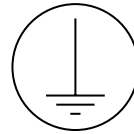

- The Wallbox must be connected to a protective earth conductor

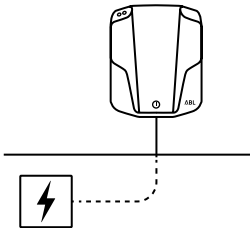

- Ideally, the installation site should already provide for connection to the electricity grid.
- Otherwise, a power supply cable must be installed especially
- If unsure, please contact your specialist electrical contractor

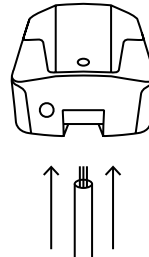

- Ideally, cable entry is from the underside of the housing base
- Above or below surface power supply possible

1. SAFETY AND USER INFORMATION

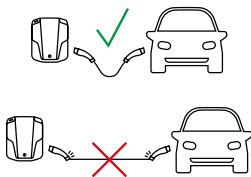

- The charging cable must not be under strain during the charging process

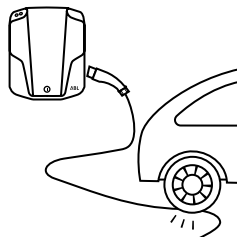

- The charging cable and the charging connector must not be driven over

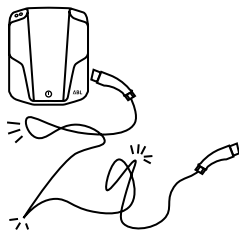

- The charging cable must not be kinked or twisted

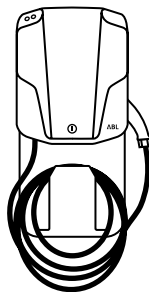

- The charging cable must be coiled tightly and stored. Accessories: p. 21

1. SAFETY AND USER INFORMATION



- (De-)installation and repairs must only be carried out by a specialist electrical contractor
- No modifications must be made to the Wallbox
- None of the components need to be maintained by the user

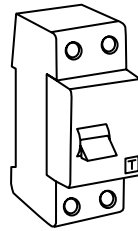

- The Wallbox must be protected by a Type A RCCB.
- Depending on the model variant, it may already be incorporated into the eMH1 Wallbox, or it must be installed upstream by the specialist electrical contractor

1. SAFETY AND USER INFORMATION

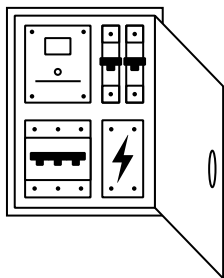

- The power supply in the domestic power distribution box must be protected separately by a suitable and accurately dimensioned miniature circuit breaker (C characteristic)

The eMH1 Wallbox

- Complies with all technical safety requirements, standards and guidelines. Standards & guidelines: p. 86
- Represents the current state of technology

- From October 2018, all eMH1 Wallbox model variants are equipped with an RCM14
- DC fault current detection is required by law in many countries
- The RCM14 means there is no need for a Type B RCCB

1. SAFETY AND USER INFORMATION

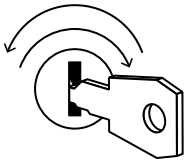

- The housing cover of the Wallbox must be locked

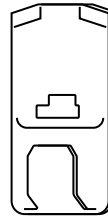

- Only accessories intended for the Wallbox and supplied by the manufacturer must be used.
Accessories: p. 21

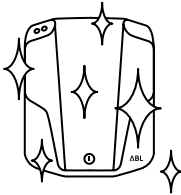

- The Wallbox must only be cleaned using a dry cloth
- No pressure cleaners or similar devices must be used

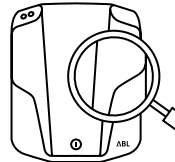

- The Wallbox must be checked regularly for its technically sound condition
- The 'T' button of the RCCB must be tripped once every 6 months. See the operating manual available at www.abl.de
- In case of damage, contact your local distributor first

INTRODUCTION

2. Your model variant	18
3. Components included	20
4. Accessories	21

2. YOUR MODEL VARIANT

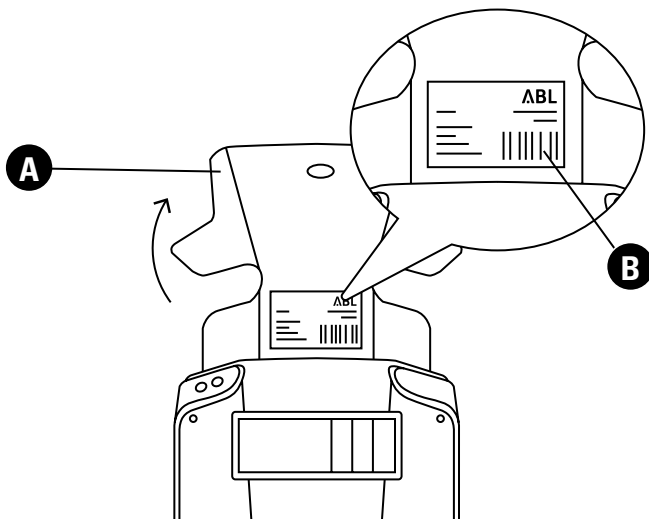

1 Open the cover

A Cover

2 The type plate is located under the cover

B Type plate

3 p. 19

2. YOUR MODEL VARIANT



A Model number

B Power supply (voltage, frequency, current)

C IP rating

D Standard

E Standard

F Country of manufacture

G Manufacturer

H Manufacturer's logo

I Disposal advice

J 'Read instructions' advice

K CE label

L Barcode

M Serial Number

N Date printed

3 You can find your model variant on p. 81 using the data shown at **A**

3. COMPONENTS INCLUDED

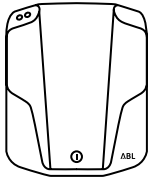

eMH1 Wallbox

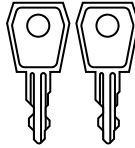

2 x keys

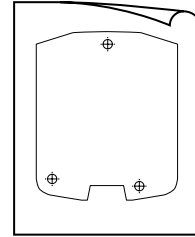

Drilling template



Installation manual

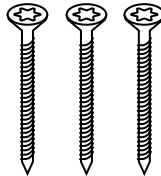

3 x screws (countersunk, 5 x 60 mm, T20)

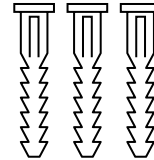

3 x wall plugs (8 x 40 mm)

- 1 Check immediately after unpacking whether all components are included
- 2 In case of missing components, please contact your local distributor

4. ACCESSORIES



Mounting pole*

Powder-coated metal mounting pole with LED lighting, suitable for all eMH1 Wallboxes with or without mounting plate
h = 1650, w = 285, d = 150

*Wallbox not included

Foundation block for eMH1 mounting pole

For ground installation of the mounting pole, ABL offers a precast foundation block, which provides the necessary stability and security for the pole and has an integrated tube to protect the power supply. The foundation block is made from grade C 25/30 concrete and complies with exposure classes XC4 and XF1. 4 x M12 V2A mounting screws are included.

4. ACCESSORIES



Mounting plate

for all eMH1 Wallboxes

USB/RS485 Converter

To select charging currents via a serial
RS485 interface on the EVCC Virtual
COM-Port

USB: Type B

RS485: RJ12 and MOLEX 5557

incl. software and two supply cables

4. ACCESSORIES



homeCLU

A future-oriented solution for the efficient and safe distribution of the existing domestic power supply. Suitable for load management

with all eMH1 Wallboxes incl. control unit, phase current measurement, power adapter and RS485-USB-adapter cable.

Further information available at www.abl.de
Installation p.43



4. ACCESSORIES



Type 2 charging cable

acc. to IEC 62196-2 · 32 A 240 /415 V AC 3-phase
Length ca. 4 m IP44 splash protection rating



Type 2

Type 2 charging cable

acc. to IEC 62196-2 · 20 A 240 /415 V AC 3-phase
Length ca. 7m IP44 splash protection rating



Type 2

Type 2 to Type 1 adapter cable

32 A 230 V AC · length ca. 4 m · single phase
splash proof (IP44)



Type 2



Type 1

MECHANICAL INSTALLATION

5. Preparing for mechanical installation	26
6. Fixing points	28
7. Power supply entry	31
8. Mounting	34



[www.abl.de / Service / Downloads](http://www.abl.de/Service/Downloads)

This chapter is available on video

5. PREPARING FOR MECHANICAL INSTALLATION

Tools

Cut power source

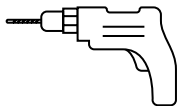

Electric drill



Drill bit (B 8 mm)

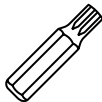

Bit (Torx T20)

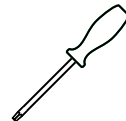

Screwdriver
(Phillips head)

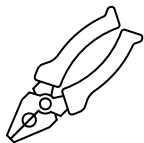

Pliers

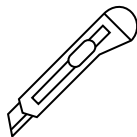

Utility knife



Scissors



Pencil

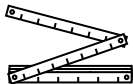

Tape measure

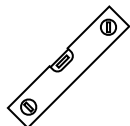

Spirit level

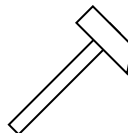

Hammer

Components included

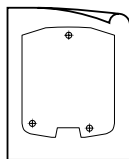

Drilling template



Wall plug
(8 x 40 mm)



Screw (countersunk,
5 x 60 mm, T20)

5. PREPARING FOR MECHANICAL INSTALLATION

Tools
Cut power source

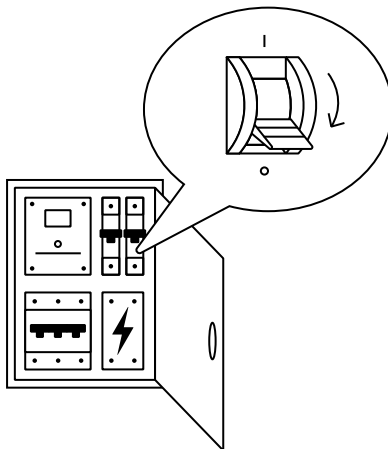

- 1 Switch off the circuit breaker in the domestic power distribution

6. FIXING POINTS

Drilling template

Drilling

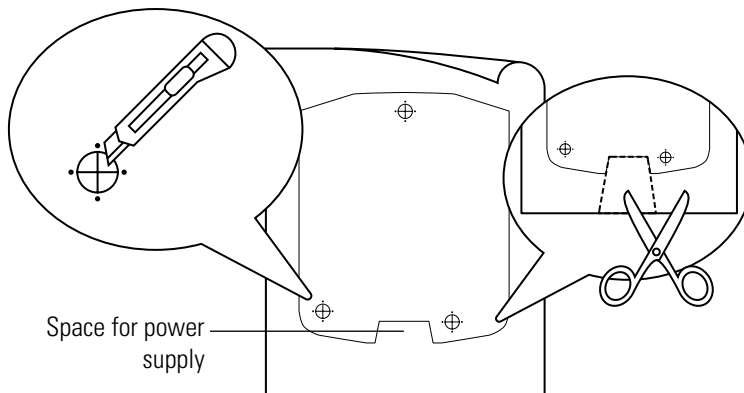

1 Cut the fixing points as marked

Tool:

Scissors

2 Cut out the space for the power supply

Tool:

Scissors



Before drilling, check the measurements of the drilling template



A separate drilling template must be used for fixing the mounting plate

⊕: Marked fixing point

6. FIXING POINTS

Drilling template

Drilling

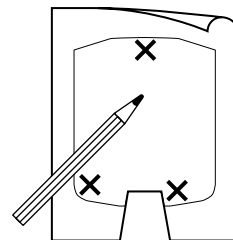
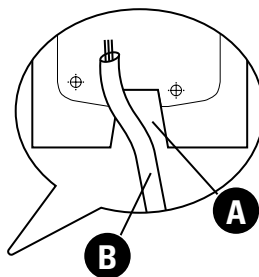
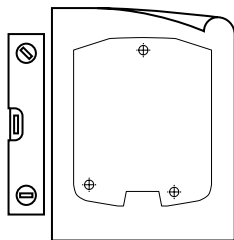

1 Place the drilling template vertically on the wall. The cut-out space marks the opening for the power supply

Tool:
Spirit level

2 Mark the fixing points on the wall

Tool:
Pencil

A Cut-out space

B Power supply cable

X Marks for fixing points

6. FIXING POINTS

Drilling template **Drilling**

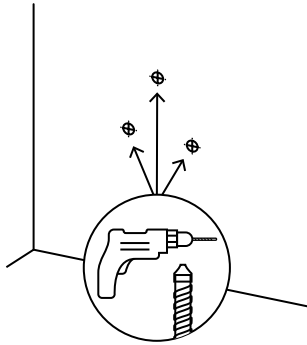

- 1** Drill holes where the fixing points are marked

Tools:

Electric drill,
drill bit (Ø8 mm)

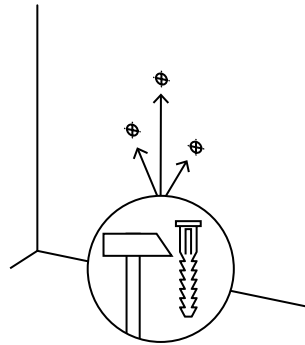

- 2** Insert the wall plugs into the fixing holes

Tools:

Wall plugs (8x40mm)
Hammer

⊕ Marked fixing point

7. POWER SUPPLY ENTRY

Upper part of housing

Plastic lug

Rubber grommet

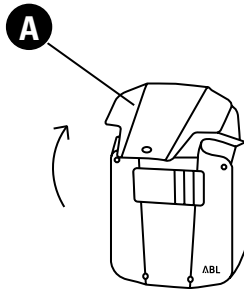

1 Open the cover

A Cover

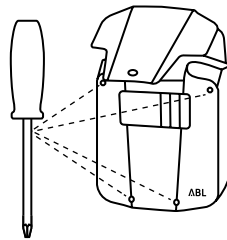

2 Loosen the four screws. The screws are located in the upper part of the housing. Keep the four screws aside

Tool:

Screwdriver
(Phillips head)

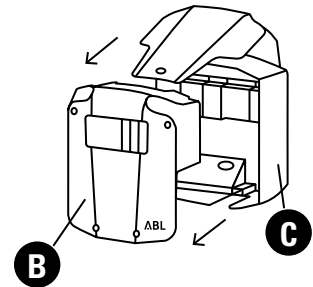

3 Remove the upper part of the housing from the housing base

B Upper part of housing

C Housing base

7. POWER SUPPLY ENTRY

Upper part of housing

Plastic lug

Rubber grommet

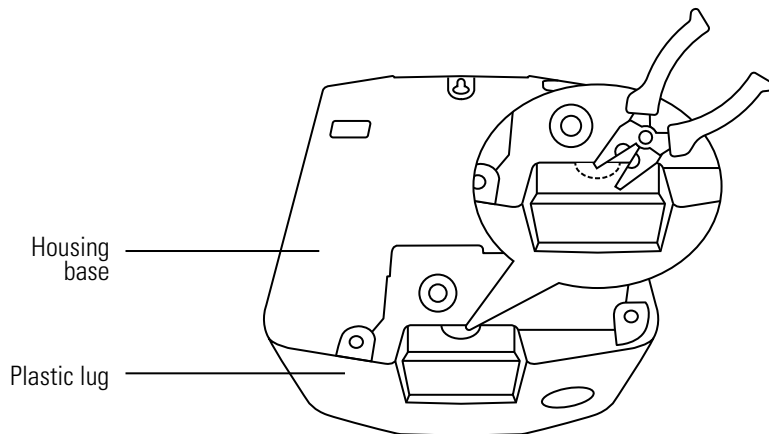

- 1 Remove the pre-stamped plastic lug to allow space for the power supply cable to enter.

The pre-stamped plastic lug is located at the bottom of the housing base



This step is only required if the power supply has been installed above the wall surface

Tool:

Pliers or utility knife

7. POWER SUPPLY ENTRY

Upper part of housing
Plastic lug
Rubber grommet

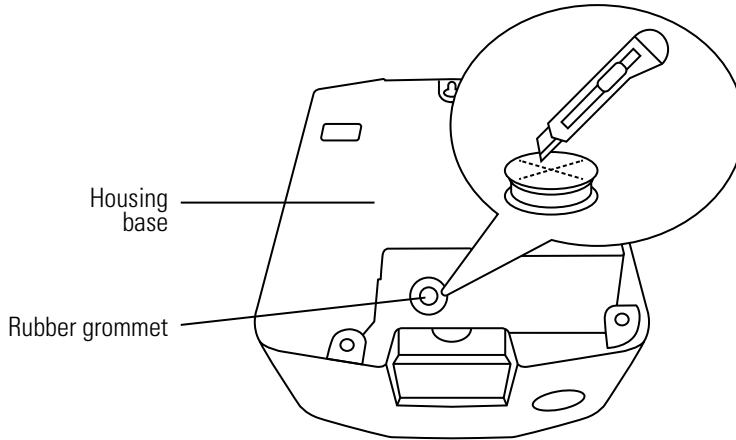

- 1** Remove the rubber grommet. The rubber grommet is located at the bottom of the housing base.
Cut an opening for the power supply cable into the membrane of the rubber grommet
- 2** Replace the rubber grommet in the opening in the housing base

Tool:

Utility knife

8. FIXING

Upper fixing point

Lower fixing points

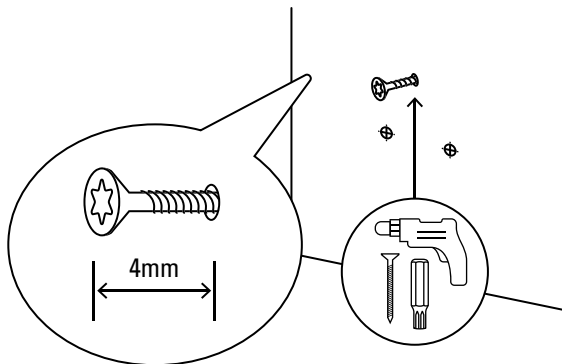

- 1 Insert a screw into the upper fixing point.
The distance between the head of the screw and the wall is 4 mm

2 p. 35

3 p. 35

4 p. 36

Tool:

Electric drill, TORX T20 bit
Screw (countersunk, 5 x 60 mm T20),
Tape measure

⊕ Marked fixing point

8. FIXING

Upper fixing point

Lower fixing points

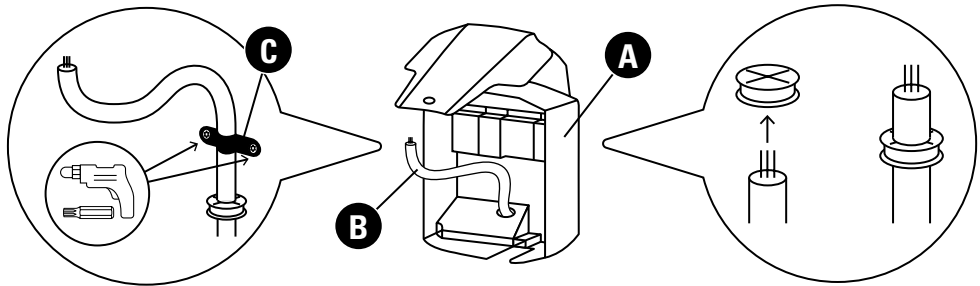

2 Loosen the internal strain relief. The strain relief is located on the inside of the housing base, above the rubber grommet

Tool:

Electric drill, TORX T20 bit

3 Feed the power supply cable through the rubber grommet

- A** Housing base
- B** Power supply cable
- C** Strain relief

4 p. 36

8. FIXING

Upper fixing point

Lower fixing points

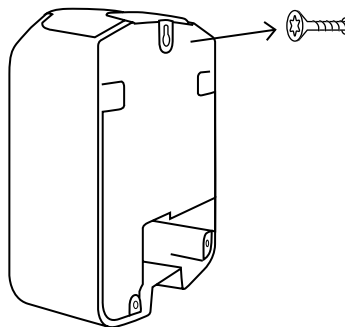

- 4** Hang the housing base onto the upper screw

8. FIXING

Upper fixing point
Lower fixing points

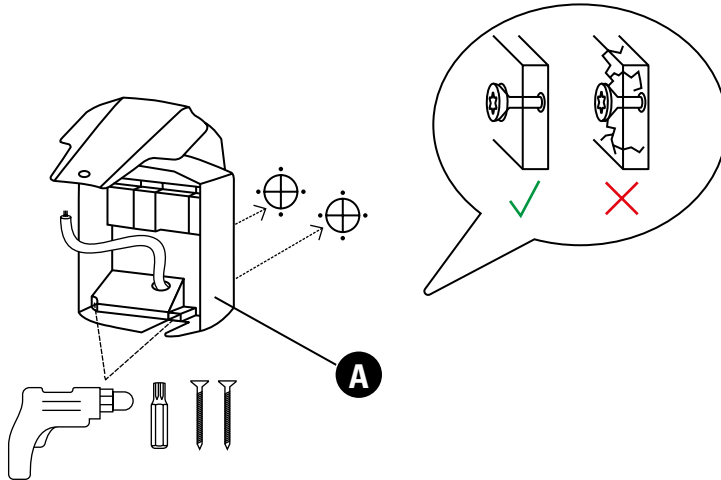

- 1 Screw the housing base to the two lower fixing points. Do not distort the housing base material

2 p. 38

Tools:

Electric drill, TORX T20 bit,
Screw (countersunk 5x60mm, T20)

⊕ Marked fixing point

A Housing base

8. FIXING

Upper fixing point
Lower fixing points

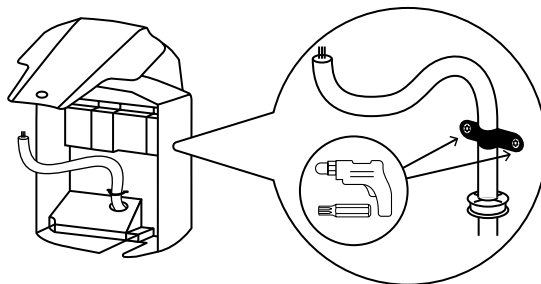

- 2 Fix the power supply to the internal strain relief

Tools:

Electric drill, TORX T20 bit

ELECTRICAL INSTALLATION

9. Preparing for electrical installation	40
10. homeCLU	43
11. Electrical installation	51
12. Start-up	58



[www.abl.de / Service / Downloads](http://www.abl.de/Service/Downloads)

This chapter is available on video

9. PREPARING FOR ELECTRICAL INSTALLATION

Tools

Cut power source

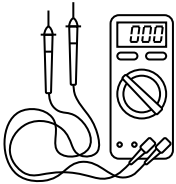

Voltmeter

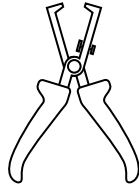

Wire stripper

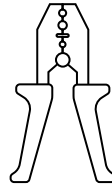

Crimp tool



Screwdriver
(Phillips head)

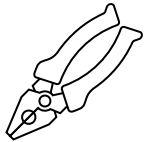

Pliers

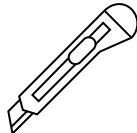

Utility knife

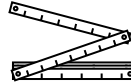

Tape measure

Components included

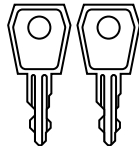

2x keys

9. PREPARING FOR ELECTRICAL INSTALLATION

A qualified specialist electrical contractor must carry out electrical installation and take the Wallbox into operation. All local regulations and standards for the installation of electrical devices must be complied with.

The five golden rules of electrical installation must always be observed:

- 1 Cut power source
- 2 Secure all cut-off devices
- 3 Verify absence of voltage
- 4 Ground and short-circuit
- 5 Cover or bar access to adjacent components under voltage



- Before installation, the circuit breaker for the Wallbox in the domestic power distribution must be switched off
- The MCB must not be switched back on during installation.

9. PREPARING FOR ELECTRICAL INSTALLATION

Tools
Cut power source

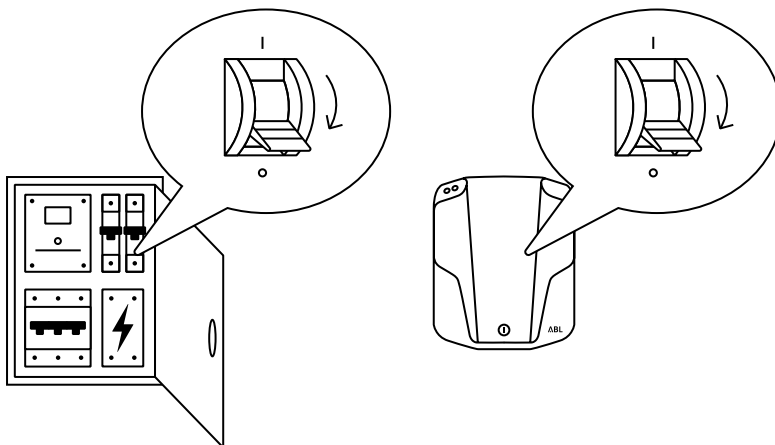

1 Switch off the circuit breaker in the domestic power distribution

2 Switch off the RCCB in the Wallbox and/or the domestic power distribution



This chapter is only required if homeCLU is installed

Please observe the following points before installation:

- Number of charge points
- Main inlet fuse size
- Total charging current required per phase
- Sum of the charging currents for all charge points
- Available charging current for each charge point
- Domestic grid connection type: TN, IT or TT network
- Single or 3-phase charging
- Identify and label the phases of the power supply at the main inlet fuse
- Plan a connection pattern. Identify the phase(s) leading from the inlet fuse to the charge point(s)
- Allocate a unique designation to every charge point

10. homeCLU

Connecting eMH1

Configuring eMH1

Connecting homeCLU

- 1-phase charging
- Phase rotation
- TN network

- 3-phase charging
- Phase rotation
- TN network

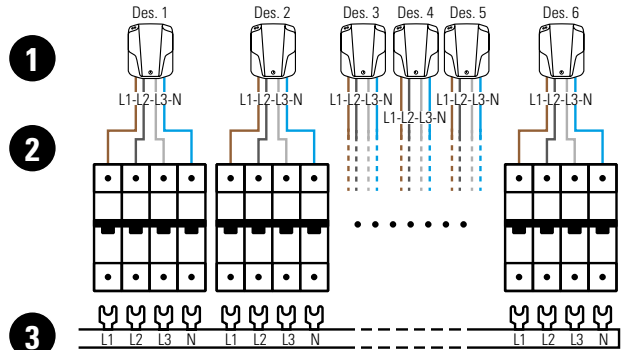
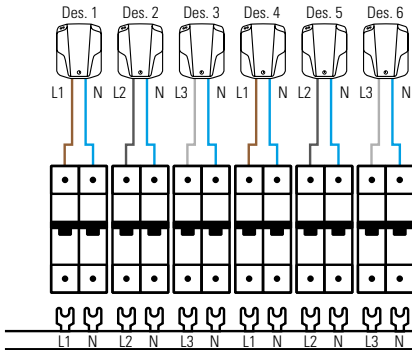

1 Connect all charge points according to the respective pattern

2 When connecting charge points to the fuses or terminal blocks, rotate the phase sequence one step each time

3 Conventional 'L1-L2-L3-N' busbars suitable for 4-pole DIN block devices may be used to distribute phases



The protective earth connection is purposely not included in the installation diagrams



Further information regarding electrical installation: p. 51

10. homeCLU

Connecting eMH1

Configuring eMH1

Connecting homeCLU



- The system will not work as intended if the phases do not correspond
- All Wallboxes must be connected to the same grounding point – otherwise communication may be lost or the homeCLU unit may be damaged



Phase rotation

- must also be followed if fewer than 6 charge points are connected
- ensures equal load distribution among all the phases in the system
- is important for single phase as well as 3-phase charging of single phase vehicle designs

10. homeCLU

Connecting eMH1

Configuring eMH1

Connecting homeCLU

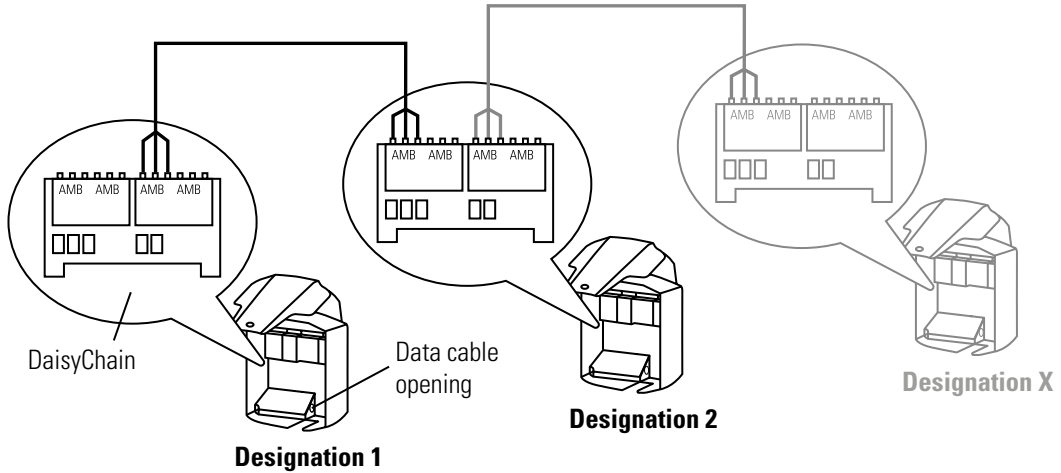

- 1** Insert the data cable through the lower opening in the housing base
- 2** Connect the data cable with the plug-in connection inside the Wallbox. The plug-in connection is located on the DaisyChain at the upper left edge of the housing base, next to the PE terminal
- 3** Repeat steps 1-2 for additional Wallboxes



- The data cable has at least 2 intertwined pairs of conductors
- Data conductors A and B are intertwined
- Conductors A, B and M must be connected to each Wallbox following the same pattern

10. homeCLU

Connecting eMH1
Configuring eMH1
Connecting homeCLU

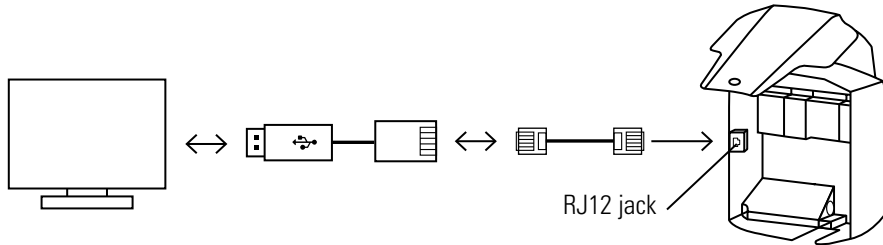

- 1** Connect the RJ12 cable with the RJ12 jack. The RJ12 jack is located at the left hand edge of the housing base
- 2** Connect the free end of the RJ12 cable to the RJ12 jack of the RJ12 to USB adapter
- 3** Connect the USB plug to the computer
- 4** Open the configuration software and follow the instructions



To obtain the configuration software, contact technical support: p. 92

10. homeCLU

Connecting eMH1
Configuring eMH1
Connecting homeCLU

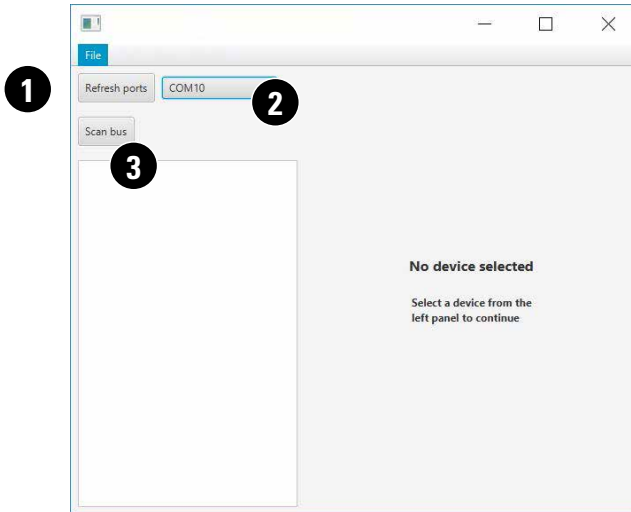

1 Click on the 'Refresh ports' button

2 Use the drop-down menu to select the top COM-port

3 Click the 'Scan bus' button

10. homeCLU

Connecting eMH1
Configuring eMH1
Connecting homeCLU

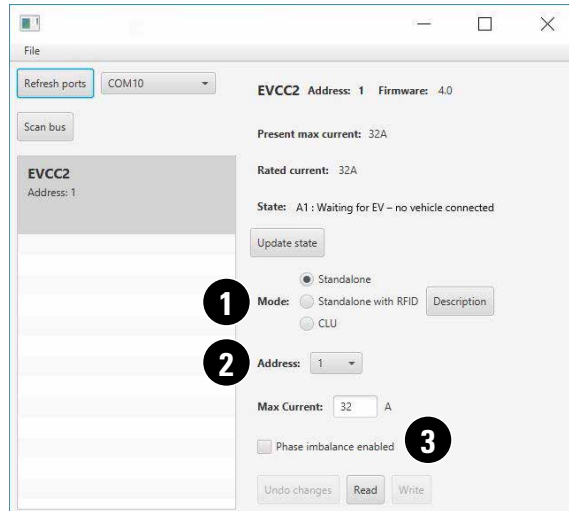

- 1 Tick 'CLU'
- 2 Select the intended designation from the drop-down menu
- 3 Click the 'write' button



The planned connection pattern determines the designations. Connection pattern: p. 44 and in the separate CLU installation diagrams

For single phase charging

- without phase rotation
- with no more than two charge points designations 1 and 2 must be used

10. homeCLU

Connecting eMH1
Configuring eMH1
Connecting homeCLU

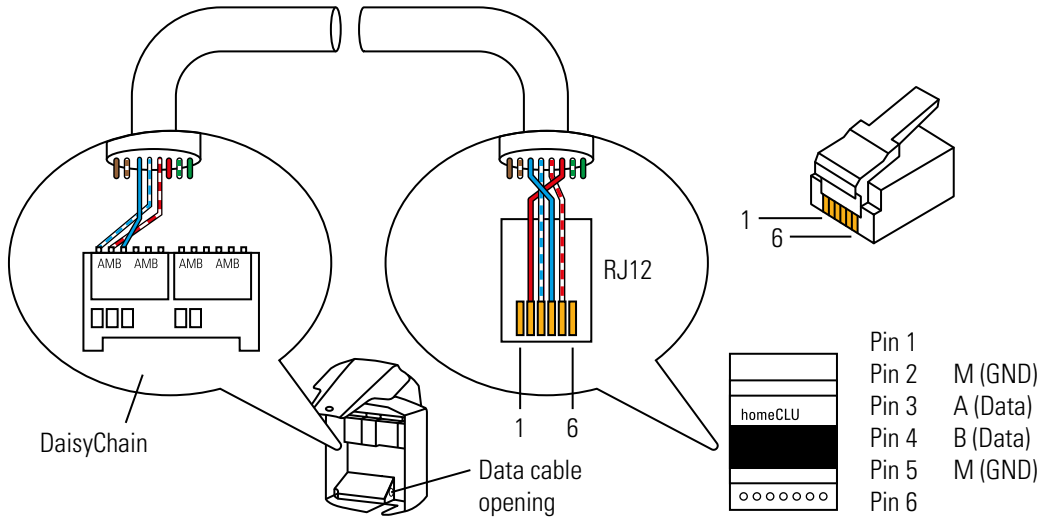

- 1 Insert the data cable through the lower opening in the housing base
- 2 Connect the free end of the data cable with the plug-in connection inside the Wallbox. The plug-in connection is located on the DaisyChain at the upper left hand edge of the housing base, next to the PE terminal
- 3 Crimp the RJ12 plug onto the data cable
- 4 Connect the data cable to the homeCLU unit



- The data cable has at least 2 intertwined pairs of conductors
- Data conductors A and B are intertwined
- Conductors A, B and M must be connected following the same pattern

Further information: See the homeCLU installation manual and www.abl.de

11. ELECTRICAL INSTALLATION

Supply cable

entry
Activation

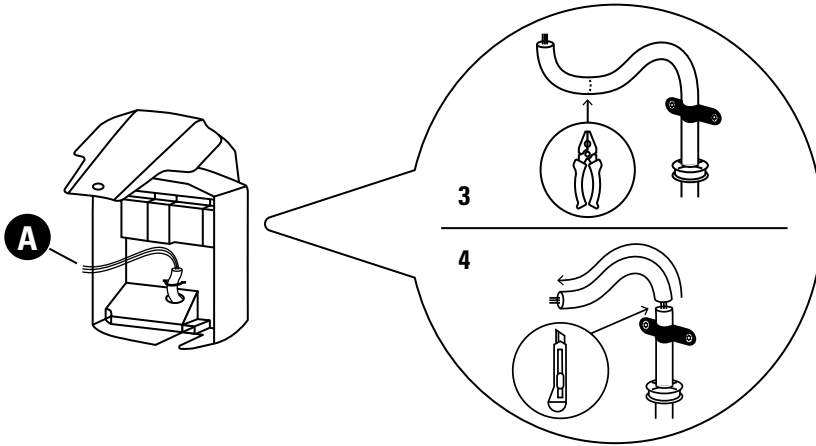

- 1 Cut the supply cable to the required length.

Tool:
Pliers

- 2 Strip the oversheath and screen from the power cable beginning at the strain relief **3-5** p. 52
6-7 p. 53

Tool:
Cutter or wire stripper

- A** Power supply cable

11. ELECTRICAL INSTALLATION

Supply cable
Installation
Activation

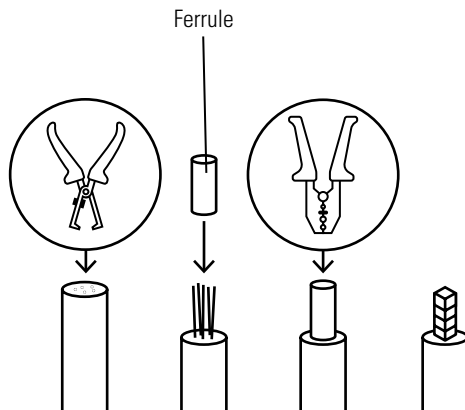

3 Strip the cable

4 Put ferrule on wires

5 Crimp on the ferrule

6-7 p. 53

Tool:

Wire stripper

Tool:

Crimp tool

11. ELECTRICAL INSTALLATION

Supply cable
Installation
Activation

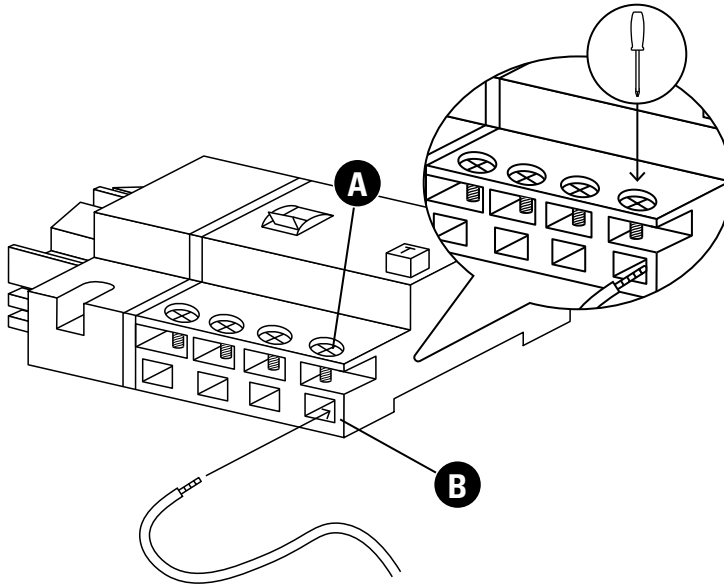

6 Insert the individual conductors of the power supply cable into the intended terminal blocks

Allocation: p. 54

7 Screw the cables down in the terminal blocks

Tool:

Screwdriver
(Phillips head)

- A** Terminal block screw
- B** Terminal block opening



- Screws and cables may have become loose during transport
- All screws and cables installed must
 - Be checked
 - Tightened if required

11. ELECTRICAL INSTALLATION

Supply cable
Installation
Activation

Designation	Conductor color	Connection coding	Phase system
Phase 1 current-carrying conductor	Brown	L1	single phase 3-phase
Phase 2 current-carrying conductor	Black	L2	3-phase
Phase 3 current-carrying conductor	Gray	L3	3-phase
Neutral	Blue	N	single phase 3-phase
Protective earth	Green-Yellow	PE	single phase 3-phase



The color-coding given above
is not internationally standardized

11. ELECTRICAL INSTALLATION

Supply cable
Installation
Activation

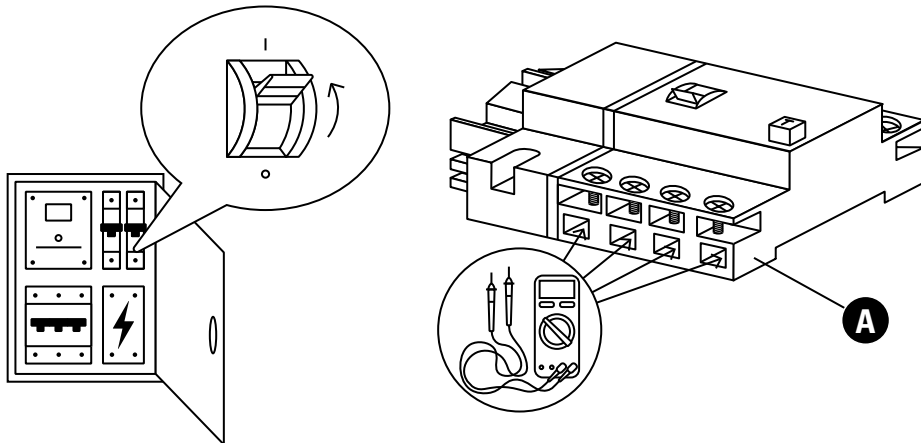

1 Switch on the circuit breaker in the domestic power distribution

2 In single phase systems, the voltage is measured at the openings of the phase and neutral conductor connections. In 3-phase systems, all phases are measured against each other (400V) and all phases are measured against the neutral conductor (230V)

3 p. 56

4 p. 56

5 p. 57

6 p. 57

A Opening
Terminal block

Tool:
Voltmeter

11. ELECTRICAL INSTALLATION

Supply cable
Installation
Activation

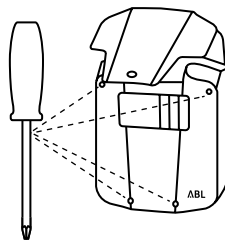
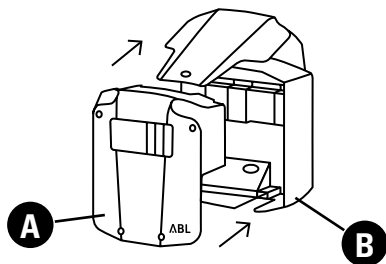

3 Place the upper part of the housing onto the housing base

A Upper part of housing

B Housing base

4 Fix the upper part of the housing to the housing base using the screws kept for this purpose

5 p. 57

6 p. 57

Tools:

Screwdriver (Phillips head)
screw kept aside from p. 31

11. ELECTRICAL INSTALLATION

Supply cable
Installation
Activation

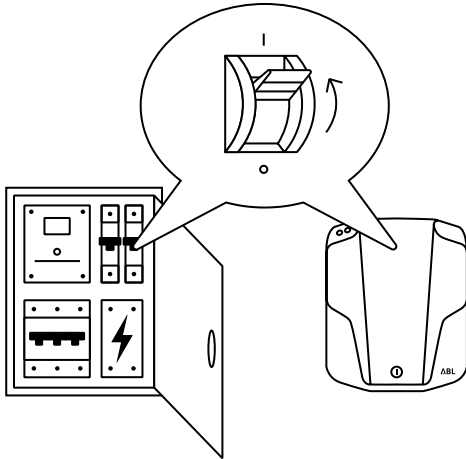

- 5** Switch on the RCCB in the Wallbox and/or the domestic power distribution

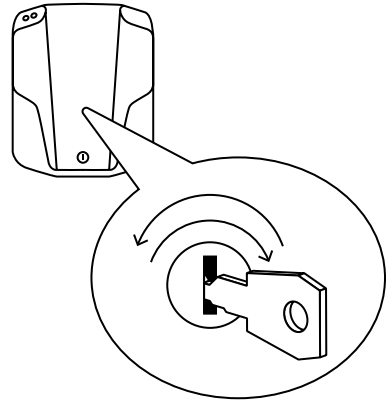

- 6** Lock the housing cover

Tool:
Key

12. START-UP

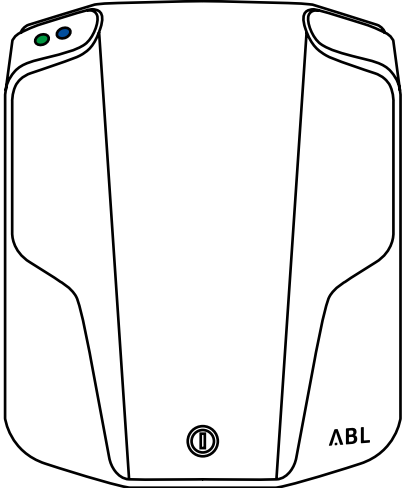

LED operating states



On



Flashing



Off



On



Flashing



Off

12. START-UP

Sequence S1

The Wallbox is starting up

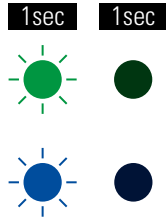

Both LEDs are flashing
Both LEDs are Off

- 1 Check that the LED indicators of the Wallbox display this operating state
- 2 p. 60
- 3 p. 61

12. START-UP

Sequence S2

The Wallbox indicates the current software version

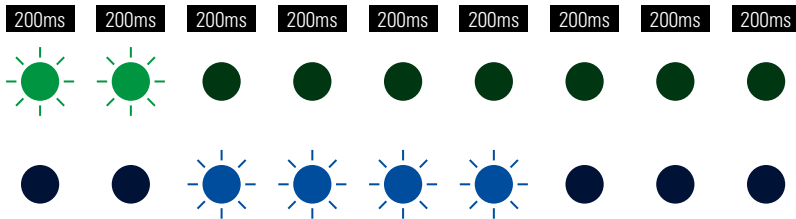

The green LED flashes depending on the software version
Then the blue LED flashes according to the software version

- 2 Check that the LED indicators of the Wallbox display this operating state



Example: For the 2.4 software version, the green LED flashes twice and the blue LED four times

12. START-UP

Sequence A

The Wallbox is ready for use

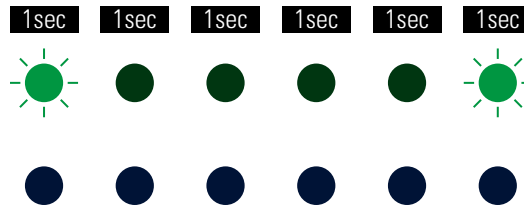

The green LED flashes every 5 seconds
The blue LED is continuously Off

- 3 Check that the LED indicators of the Wallbox display this operating state. The vehicle may be connected

CHARGING PROCEDURE

13. Charging

64



[www.abl.de / Service / Downloads](http://www.abl.de/Service/Downloads)

The comprehensive operating manual contains the following chapters:

- Error messages and resolving errors
- Taking energy consumption readings
- Testing the RCCB
- Taking the device temporarily or permanently out of operation

13. CHARGING

Before the charging procedure

During the charging procedure

After the charging procedure

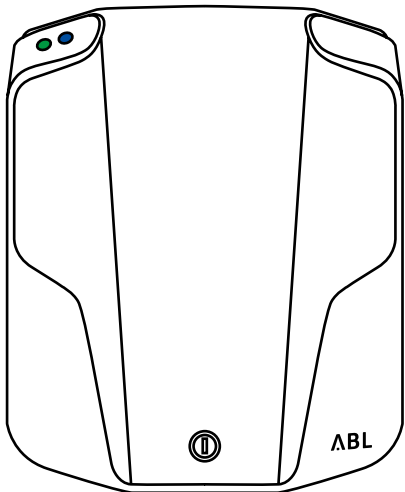

LED operating states



On



Flashing



Off



On



Flashing



Off

13. CHARGING

Before the charging procedure

During the charging procedure

After the charging procedure

Sequence A

The Wallbox is ready for use

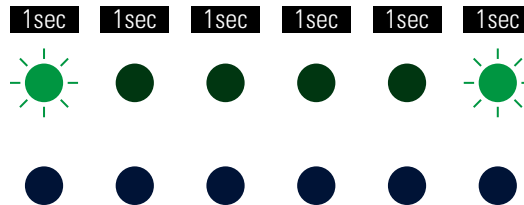

The green LED flashes every 5 seconds

The blue LED is continuously Off

- 1 Check that the LED indicators of the Wallbox display this operating state. The vehicle may be connected



Error messages are also displayed via the LEDs:

See the operating manual available at www.abl.de

13. CHARGING

Before the charging procedure

During the charging procedure

After the charging procedure

TYPE 1 CHARGING CABLE

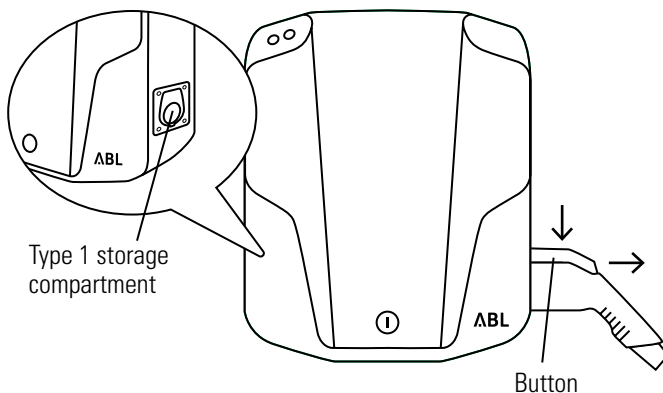

1 Keep the button on the Type 1 charging connector pressed down. The button is located on the top of the Type 1 charging connector

2 Pull the Type 1 charging connector from the Type 1 storage compartment

3 p. 69

4 p. 69

13. CHARGING

Before the charging procedure

During the charging procedure

After the charging procedure

TYPE 2 CHARGING CABLE

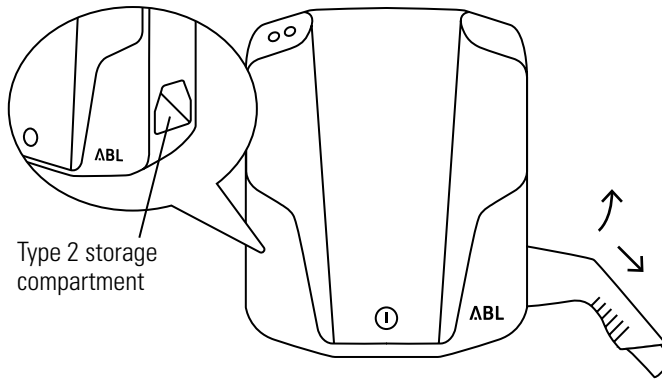

1 Gently lift the Type 2 charging connector from its storage compartment

2 Pull the Type 2 charging connector down to remove it from the Type 2 storage compartment

3 p. 69

4 p. 69

13. CHARGING

Before the charging procedure

During the charging procedure

After the charging procedure

TYPE 2 CHARGING SOCKET

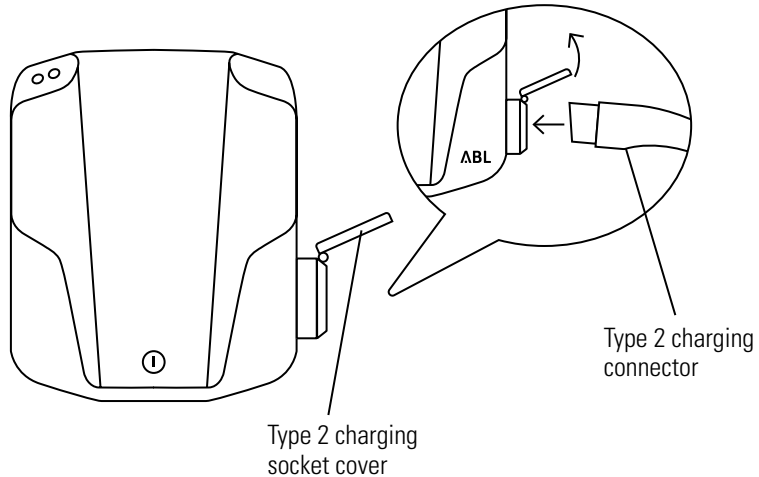

1 Open the cover of the Type 2 charging socket

2 Plug the Type 2 charging connector into the Type 2 charging socket

3 p. 69

4 p. 69

13. CHARGING

Before the charging procedure

During the charging procedure

After the charging procedure

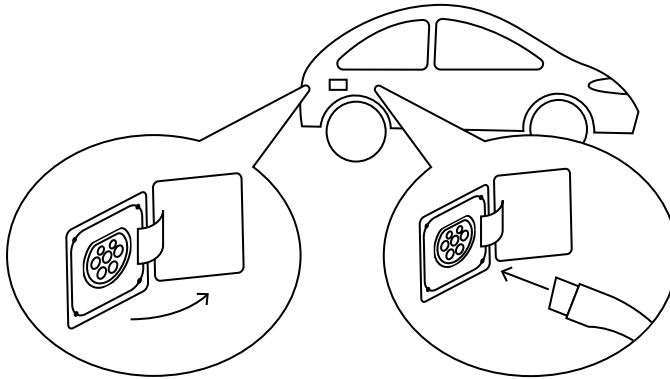

3 Open the vehicle's charging socket

4 Plug the charging connector into the vehicle's charging socket

13. CHARGING

Before the charging procedure
During the charging procedure
After the charging procedure

Sequence B1

The Wallbox is waiting for the vehicle to initiate the charging procedure

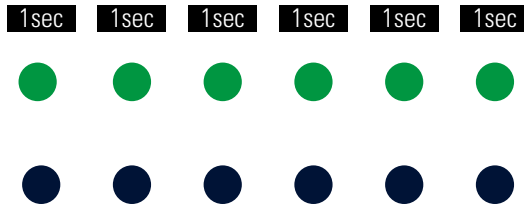

The green LED is continuously On
The blue LED is continuously Off

1 Check that the LED indicators of the Wallbox display this operating state. The charging procedure will start automatically as soon as the vehicle has been recognised

2 p. 71
3 p. 72



The charging procedure will only start when

- the vehicle has been connected
- the vehicle's charging timer is activated

13. CHARGING

Before the charging procedure
During the charging procedure
After the charging procedure

Sequence C2

The Wallbox is charging

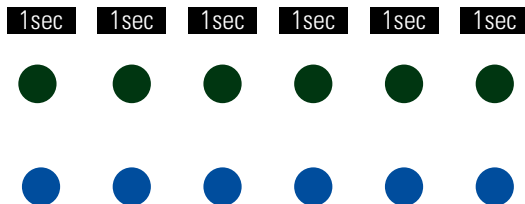

The green LED is continuously Off
The blue LED is continuously On

- 2 Check that the LED indicators of the Wallbox display this operating state. The charging procedure will start automatically as soon as the vehicle has been recognized

13. CHARGING

Before the charging procedure
During the charging procedure
After the charging procedure

Sequence B2

The charging procedure has been interrupted or completed

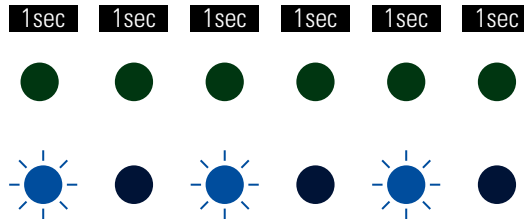

The green LED is continuously Off
The blue LED flashes every 2 seconds

- 3 Check that the LED indicators of the Wallbox display this operating state. The charging procedure can be interrupted manually at the vehicle. The charging procedure is automatically terminated by the vehicle when the charging procedure has been completed

13. CHARGING

Before the charging procedure
During the charging procedure
After the charging procedure

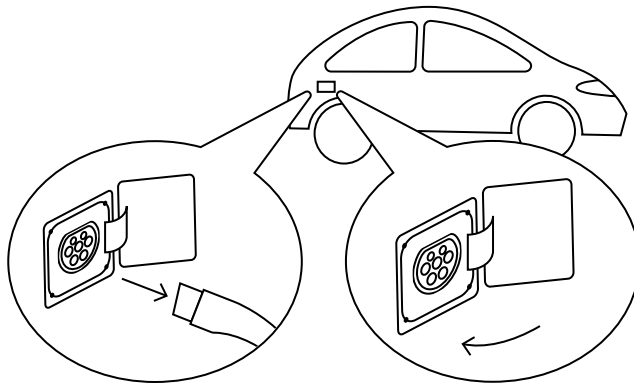

- 1** Pull the charging connector from the vehicle's charging socket.
 - 2** Close the vehicle's charging socket
- 3-5** Type 1 charging cable: p. 74
Type 2 charging cable: p. 75
Type 2 charging socket: p. 76
- 6** p. 77

13. CHARGING

Before the charging procedure
During the charging procedure
After the charging procedure

TYPE 1 CHARGING CABLE

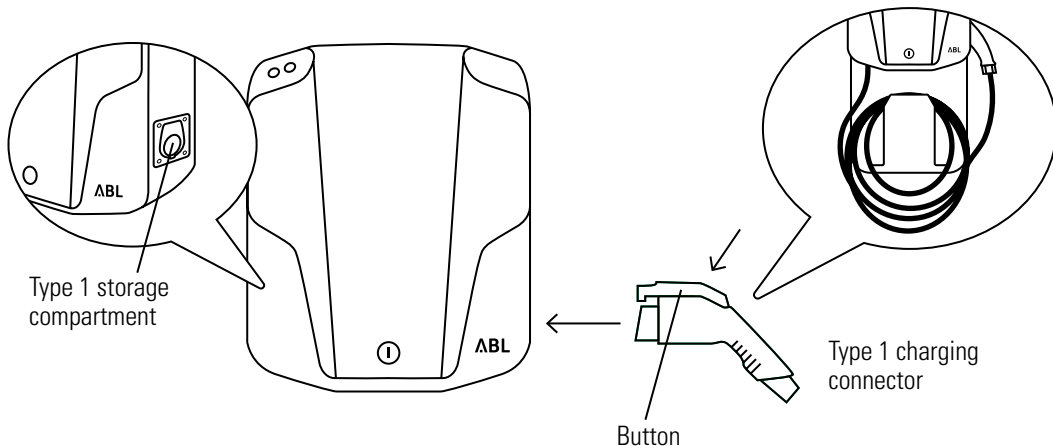

3 Keep the button on the Type 1 charging connector pressed down. The button is located on the top of the Type 1 charging connector

4 Insert the Type 1 charging connector into the Type 1 storage compartment

5 Coil the charging cable up tightly and store it, ready for the next charging procedure

6 p. 77



After the charging procedure, the charging connector must not

- be exposed
- remain plugged into the vehicle

13. CHARGING

Before the charging procedure
During the charging procedure
After the charging procedure

TYPE 2 CHARGING CABLE

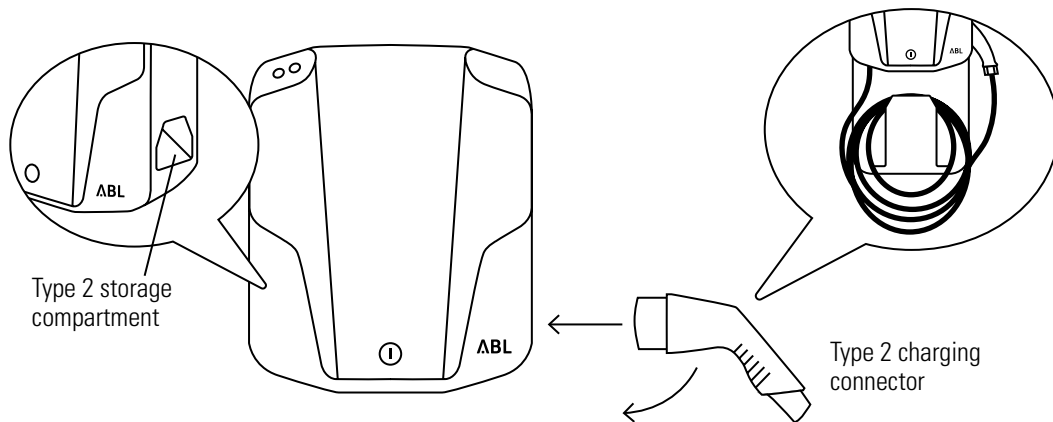

3 Slowly plug the Type 2 charging connector into the Type 2 storage compartment

4 Gently lower the Type 2 charging connector

5 Coil the charging cable up tightly and store it, ready for the next charging procedure

6 p. 77



After the charging procedure, the charging connector must not

- be exposed
- remain plugged into the vehicle

13. CHARGING

Before the charging procedure
During the charging procedure
After the charging procedure

TYPE 2 CHARGING SOCKET

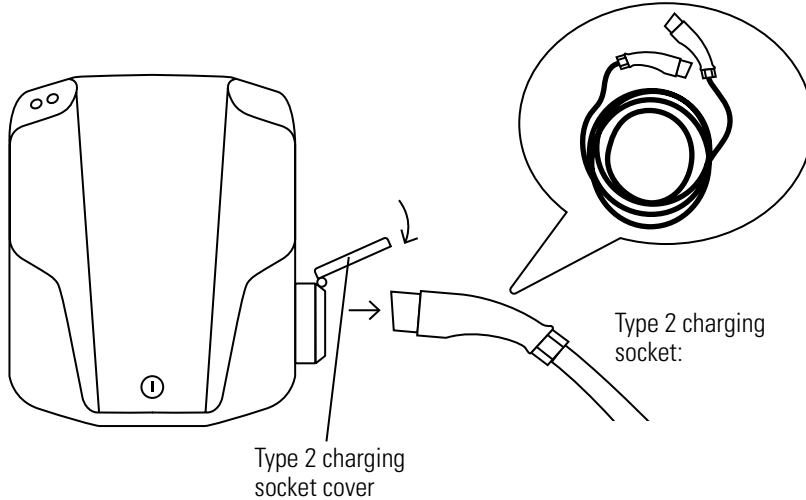

- 3 Pull the Type 2 charging connector from the Type 2 charging socket
- 4 Close the cover of the Type 2 charging socket

- 5 Coil the charging cable up tightly and store it, ready for the next charging procedure

6 p. 77



- After the charging procedure, the charging connector must not
- be exposed
 - remain plugged into the vehicle

13. CHARGING

Before the charging procedure
During the charging procedure
After the charging procedure

Sequence A

The Wallbox is ready for use

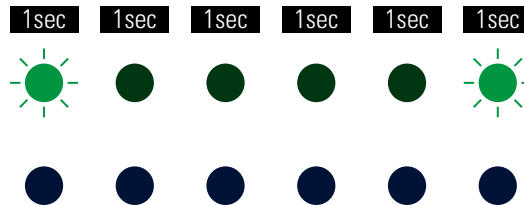

The green LED flashes every 5 seconds
The blue LED is continuously Off

- 6 Check that the LED indicators of the Wallbox display this operating state. The vehicle may be connected



- The actual charging time depends on the battery fitted to your vehicle as well as on the charge currently remaining in the battery
- For these reasons it is not possible to make a firm prediction of the charging time

APPENDIX

14. Definitions	80
15. Specifications	81
16. Standards, guidelines and trademarks	86
17. Warranty and guarantee provisions	89
18. Disposal advice	91

14. DEFINITIONS

ABBREVIATION	EXPLANATION
DC	Direct Current
eMH1	Electric Mobility Home
EVCC	Electric Vehicle Charge Control
RCBO	Residual current operated Circuit Breaker with Overcurrent protection
RCCB	Residual Current Circuit Breaker
LED	Light Emitting Diode
RCM	Residual Current Monitor
RFID	Radio Frequency Identification
'T'-button	Testing button

15. TECHNICAL SPECIFICATIONS

Model code 11kW	1W1121 1W11K2 1W11N2	1W1101 1W11K1 1W11N1
Rated voltage	230/400 V	230/400 V
Grid frequency	50 Hz	50 Hz
Current	16 A	16 A
Charging output	11 kW	11 kW
Charging connection	Type 2 charging socket	Type 2 charging cable (ca. 6m)
Phase system	3-phase	3-phase
Residual-Current Devices	RCCB, Type A, 30 mA	RCCB, Type A, 30 mA
DC fault current detection	DC-RCM, I Δ n d.c. \geq 6 mA	DC-RCM, I Δ n d.c. \geq 6 mA
EVCC	2	2
Compliance	IEC 61851-1	IEC 61851-1
Control / Customization	Internal RS485 interface	Internal RS485 interface
Terminal block	up to 50 mm ²	up to 50 mm ²
Operating temperature	-30°C to 50°C	-30°C to 50°C
Storage temperature	-30°C to 85°C	-30°C to 85°C
Rel. humidity	5 to 95% (no condensation)	5 to 95% (no condensation)
Class of protection	I	I
Degree of protection (housing)	IP44	IP54
Overvoltage category	III	III
Dimensions	272 x 221 x 116 mm (H x W x D)	272 x 221 x 116 mm (H x W x D)
Weight per unit	ca. 3 kg	ca. 4.5 kg

15. TECHNICAL SPECIFICATIONS

Model code 3.6 kW	1W36P1
Voltage	230 V
Grid frequency	50 Hz
Current	16 A
Charging output	3.6 kW
Charging connection	Type 2 charging cable (ca. 6m)
Phase system	1-phase
Residual-Current Devices	RCCB, Type A, 30 mA
DC fault current detection	DC-RCM, $I_{\Delta n}$ d.c. ≥ 6 mA
EVCC	2
Compliance	IEC 61851-1
Control / Customization	Internal RS485 interface
Terminal block	up to 50 mm ²
Operating temperature	-30°C to 50°C
Storage temperature	-30°C to 85°C
Rel. humidity	5 to 95% (no condensation)
Class of protection	I
Degree of protection (housing)	IP54
Overvoltage category	III
Dimensions	272 x 221 x 116 mm (H x W x D)
Weight per unit	ca. 4.5 kg

15. TECHNICAL SPECIFICATIONS

Model code 7.2 kW	1W7221 1W72P2	1W7201 1W72P1	1W7241
Voltage	230 V	230 V	230 V
Grid frequency	50 Hz	50 Hz	50 Hz
Current	32 A	32 A	32 A
Charging output	7.2 kW	7.2 kW	7.2 kW
Charging connection	Type 2 charging socket	Type 2 charging cable (ca. 6m)	Type 2 charging cable (ca. 5m)
Phase system	1-phase	1-phase	1-phase
Residual-Current Devices	RCCB, Type A, 30 mA	RCCB, Type A, 30 mA	RCCB, Type A, 30 mA
DC fault current detection	DC-RCM, $I_{\Delta n}$ d.c. ≥ 6 mA	DC-RCM, $I_{\Delta n}$ d.c. ≥ 6 mA	DC-RCM, $I_{\Delta n}$ d.c. ≥ 6 mA
EVCC	2	2	2
Compliance	IEC 61851-1	IEC 61851-1	IEC 61851-1
Control / Customization	Internal RS485 interface	Internal RS485 interface	Internal RS485 interface
Terminal block	up to 50 mm ²	up to 50 mm ²	up to 50 mm ²
Operating temperature	-30°C to 50°C	-30°C to 50°C	-30°C to 50°C
Storage temperature	-30°C to 85°C	-30°C to 85°C	-30°C to 85°C
Rel. humidity	5 to 95% (no condensation)	5 to 95% (no condensation)	5 to 95% (no condensation)
Class of protection	I	I	I
Degree of protection (housing)	IP44	IP54	IP54
Overvoltage category	III	III	III
Dimensions	272 x 221 x 116 mm (H x W x D)	272 x 221 x 116 mm (H x W x D)	272 x 221 x 116 mm (H x W x D)
Weight per unit	ca. 3 kg	ca. 4.5 kg	ca. 4 kg

15. TECHNICAL SPECIFICATIONS

Model code 22 kW	1W2221	1W2201
Voltage	230 / 400 V	230 / 400 V
Grid frequency	50 Hz	50 Hz
Current	32 A	32 A
Charging output	22 kW	22 kW
Charging connection	Type 2 charging socket	Type 2 charging cable (ca. 6m)
Phase system	3-phase	3-phase
Residual-Current Devices	RCCB, Type A, 30 mA	RCCB, Type A, 30 mA
DC fault current detection	DC-RCM, $I_{\Delta n}$ d.c. ≥ 6 mA	DC-RCM, $I_{\Delta n}$ d.c. ≥ 6 mA
EVCC	2	2
Compliance	IEC 61851-1	IEC 61851-1
Control / Customization	Internal RS485 interface	Internal RS485 interface
Terminal block	up to 50 mm ²	up to 50 mm ²
Operating temperature	-30°C to 50°C	-30°C to 50°C
Storage temperature	-30°C to 85°C	-30°C to 85°C
Rel. humidity	5 to 95% (no condensation)	5 to 95% (no condensation)
Class of protection	I	I
Degree of protection (housing)	IP44	IP54
Overvoltage category	III	III
Dimensions	272 x 221 x 116 mm (H x W x D)	272 x 221 x 116 mm (H x W x D)
Weight per unit	ca. 3 kg	ca. 4.5 kg

15. TECHNICAL SPECIFICATIONS

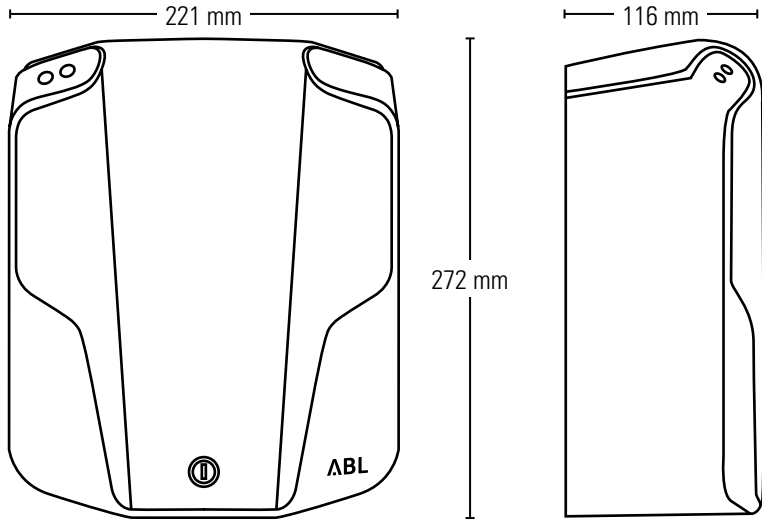

16. STANDARDS, GUIDELINES AND TRADEMARKS

GENERAL STANDARDS

2014/30/EU	EMC Directive
2011/65/EU	RoHS Directive
2012/19/EU	WEEE Directive
2014/35/EU	Low voltage directive

ELECTROMAGNETIC COMPATIBILITY STANDARDS (EMC)

IEC 61851-21-2	Conductive charging systems for electric vehicles - Part 21-2: EMC requirements for off-board electric vehicle charging systems
----------------	---

DEVICE SAFETY STANDARDS

IEC 61851-1 Ed. 3	Electrical equipment for electric road vehicles - Conductive charging systems for electric vehicles – Part 1: General requirements
IEC 60364-7-722 Ed. 1	Low voltage installations – Part 7-722: requirements for operation in special operating sites, premises and installations – power supply for electric vehicles

16. STANDARDS, GUIDELINES AND TRADEMARKS

All trademarks mentioned in this manual including those that may be protected by third parties are, without restriction, subject to the regulations of the respectively applicable trademark law and the property rights of the respective registered owners. All trademarks, trading names or company names marked here as such are or may be trademarks or registered trademarks of their respective owners. All rights not explicitly granted here are reserved. The absence of an explicit marking of trademarks used in this manual must not lead to the conclusion that a name is free from the rights of third parties.

16. STANDARDS, GUIDELINES AND TRADEMARKS



CE certification and declaration of compliance

The Wallbox carries the CE mark. The respective compliance declarations can be obtained from ABL SURSUM Bayerische Elektrozubehör GmbH & Co. KG on request and are available at www.abl.de for download.

17. WARRANTY AND GUARANTEE PROVISIONS

ABL provides the legally prescribed guarantee period as well as a warranty of the same duration for the country in which the product was purchased. Should the product be operated in another country, the legal provisions of the country of purchase apply nevertheless: Under no circumstances are guarantees or the warranty transferable. Should modifications of any kind have been made to the product that have not been explicitly authorized by ABL or described in the guidelines for authorized service partners, the manufacturer's warranty obligations become void with immediate effect. On-site repairs are generally excluded by the manufacturer. In case of disregard of this provision, all guarantee and warranty provisions become void with immediate effect.



Should problems occur when operating your product, please contact your local distributor immediately and clarify whether the malfunction is covered by guarantee or warranty provisions. Do not under any circumstances make alterations or repairs to your product yourself!

17. WARRANTY AND GUARANTEE PROVISIONS

ABL guarantees the proper operation of the product after delivery within the applicable legal guarantee provisions. This guarantee is limited to damage that can be shown to have resulted from normal use and obvious material or manufacturing defects. In such cases the manufacturer, in collaboration with the local distributor, will attempt to restore the proper functioning of the product. The customer will be responsible for covering any arising transport costs. However, the manufacturer further rejects any damage claims that can be shown to have resulted from improper use, neglect or modifications, from repair attempts by unauthorized persons or force majeure.



Consider leaving the final installation to a qualified and authorized electrical contractor: Should malfunctions occur that can be shown to have resulted from improper mounting and installation, all guarantee and warranty provisions will become void. Proof of proper installation (e.g. by submitting the relevant invoices) must be furnished on request before guarantee and warranty provisions come into effect.

18. DISPOSAL ADVICE



The crossed out trash can symbol indicates that electrical and electronic devices including accessories must be disposed of separate from household trash. The materials are recyclable as marked. By re-using, recycling or through other forms of processing obsolete devices, you make an important contribution to environmental protection.

CONTACT

ABL

Manufacturer

ABL Sursum
Bayerische Elektrozubehör GmbH & Co. KG

Albert-Büttner-Straße 11
91207 Lauf / Pegnitz

Germany

Phone +49(0)9123 188-0
Fax +49(0)9123 188-188

web www.abl.de
E-mail info@abl.de

Support

Phone +49(0)9123 188-600
E-mail support@abl.de



ABL

ABL SURSUM
Bayerische Elektrozubehör
GmbH & Co. KG

Albert-Büttner-Straße 11 · D-91207 Lauf/Pegnitz
Tel. +49(0)9123 188-0 · Fax +49(0)9123 188-18
info@abl.de · www.abl.de