

Charging pole

# eMC2



Installation and  
Instruction Manual

## Contact

### Manufacturer **ABL**

ABL Sursum  
Bayerische Elektrozubehör GmbH & Co. KG

Albert-Büttner-Straße 11  
91207 Lauf / Pegnitz

Germany

Phone +49(0)9123 188-0  
Fax +49(0)9123 188-188

Web [www.abl.de](http://www.abl.de)  
Email [info@abl.de](mailto:info@abl.de)

### Support

Phone +49(0)9123 188-600  
Email [emobility.support@abl.de](mailto:emobility.support@abl.de)

# Contents

Contact . . . . .	.ii
<b>Important Information . . . . .</b>	<b>.1</b>
Safety information contained in this manual . . . . .	.1
Safety notices on the device . . . . .	.1
General safety information . . . . .	.2
Operating instructions / Maintenance . . . . .	.3
<b>Scale drawings and dimensions. . . . .</b>	<b>.5</b>
Charging pole . . . . .	.5
Plinth . . . . .	.6
Foundations . . . . .	.7
<b>Introduction . . . . .</b>	<b>.8</b>
Product description . . . . .	.8
Identifying your product variant. . . . .	.9
Includes. . . . .	10
Available accessories . . . . .	11
<b>Preparing for installation . . . . .</b>	<b>13</b>
Requirements for the installation site . . . . .	13
Preparing for and setting the separately available foundation block . . . . .	14
Foundations laid by the operator . . . . .	15
<b>Installing the charging pole . . . . .</b>	<b>16</b>
Delivery and transport. . . . .	16
Mechanical installation on the EMC9999 foundation block . . . . .	17

Mechanical installation of the plinth on alternative surfaces . . . . .	18
Mechanical installation of the charging pole on the plinth . . . . .	19
Electrical installation of the charging pole. . . . .	20
<b>Taking into operation and charging procedure . . . . .</b>	<b>22</b>
Operational safety notices . . . . .	22
Preparing access control via RFID (model variants with RFID module only) . . . . .	23
Preparing access control via OCPP (EMC444K only) . . . . .	24
<b>Resolving errors . . . . .</b>	<b>26</b>
Operating status (RFID module) . . . . .	27
Error codes for RFID module operation . . . . .	27
Operational disruptions and solutions . . . . .	28
Checking the internal RCCB. . . . .	29
<b>Appendix . . . . .</b>	<b>30</b>
Specifications . . . . .	30
Standards & guidelines . . . . .	31
Trademarks . . . . .	32
Specifications for the foundation . . . . .	33
Warranty and guarantee provisions . . . . .	33
Intellectual Property & Copyright . . . . .	34
Glossary & Definitions. . . . .	35
Disposal advice . . . . .	36
CE certification and declaration of compliance. . . . .	37

# Important Information

## Safety information contained in this manual

This instruction manual contains important information for the installation and setup of the **ABL eMC2** charging station it refers to. Please ensure that you read and follow the safety notices provided.

In particular, the warnings and safety measures clearly marked in this manual must be followed. The symbols carry the following meanings:



### **DANGER!**

Sections marked with this symbol draw attention to electrical voltages that represent a danger to life and limb. Actions marked with this symbol must NOT be carried out under any circumstances.



### **CAUTION!**

Sections marked with this symbol draw attention to further hazards that may lead to damage to the station itself or to other electric devices. Actions marked with this symbol must be carried out with special care.



### **PLEASE NOTE:**

Sections marked with this symbol draw attention to further important information and particularities that are necessary for operating the device successfully. Actions marked with this symbol should be carried out as required.

## Safety notices on the device

Further safety notices and operating instructions can be found on and inside the charging pole. These symbols carry the following meanings:



### **WARNING!**

Please ensure that you read the instruction manual (this document) before you open the housing of your **eMC2** charging pole.



### **WARNING!**

After opening, dangerous electrical voltages may be present inside the housing.

## IMPORTANT INFORMATION

In case the charging pole is operated by several users, the contents of this manual and the safety notices in particular must under all circumstances be passed on or made available to each individual user.

### **General safety information**

This charging pole represents the current state of technology and fulfils all existing technical safety requirements, guidelines and norms. The safety notices in this manual serve to ensure proper installation and safe operation of the device. Disregard of or actions contrary to the safety information and instructions contained in this manual may lead to electric shock, fire and/or severe injury.

The charging pole may only be used after technically sound installation and subsequent inspection by a qualified electrical contractor. Malfunctions that affect the safety of persons, connected devices or the device itself may only be repaired by authorized or qualified specialist personnel.

In case of installation faults or malfunctions that can be traced back to faulty installation, always contact the contractor that carried out installation first. If the malfunction can still not be resolved, please contact the technical service department of ABL.

Contact us by email [emobility.support@abl.de](mailto:emobility.support@abl.de)  
or telephone +49 (0) 9123 - 188 600

Service is required when...

- ... the housing has suffered mechanical damage,
- ... the housing cover has been removed or can no longer be closed or locked,
- ... sufficient splash protection or protection against foreign bodies seems no longer present
- ... charging sockets and/or external charging cables have been functionally or visibly damaged
- ... the charging pole does not function properly or has been otherwise damaged.

Please also pay attention to the following points:

- Read this manual carefully.
- Keep this manual in a safe place where it can be accessed at all times.
- Heed all warnings.
- Follow all instructions.
- Only use accessories intended and sold for the device by the manufacturer.

- Do not install this device in close vicinity to running water or water jets. However, the **eMC2** is sufficiently protected against water splashes and sprays according to IP44.
- The **eMC2** charging pole must not be installed in explosive atmosphere areas (EX areas).
- The **eMC2** charging pole must not be installed in areas subject to flooding.
- Please note that the **eMC2** charging pole must under no circumstances be installed directly on blacktop: For safe and proper installation, a concrete foundation must be planned for with specifications according to the requirements listed on page 33.
- The charging pole must also be installed on a suitable plinth: The plinth can be obtained from **ABL** as an optional accessory (see also page "Available accessories" on page 11).
- Please note that additional overvoltage protection may be required depending on the vehicle to be connected or national regulations.
- Please note that some countries and/or different vehicle manufacturers may require a different tripping characteristic for the residual current circuit breaker (Type B). In this case, please contact your distributor.

### **Operating instructions / Maintenance**

Please note the following instructions for the operation and maintenance of your charging pole:

- The device must at all times be connected to the protective earth conductor of your power supply.
- Ensure that the rated voltage and rated current of the device comply with the parameters of your local electricity grid and that the rated output is not exceeded during charging operations.
- Comply at all times with local safety regulations for the country in which you operate the charging pole.
- To disconnect the charging pole completely from the power grid, the power supply must be cut at the upstream domestic miniature circuit breakers (MCB).
- Never install or operate the charging pole in confined spaces. It must be ensured in particular that, for charging, vehicles can be positioned at the required distance from the charging pole and connected without any strain on the charging cable.
- Make sure that the door at the front of the charging pole is always locked to prevent unauthorized opening of the housing. Keep the door key in a place that is only known to authorized users.

## IMPORTANT INFORMATION

- You must under no circumstances make any changes to the housing or the internal wiring of the device: Any disregard of this instruction fundamentally breaches the guarantee provisions and voids the warranty with immediate effect.
- No parts to be maintained by the user are located inside the device.
- Only have qualified, specialist personnel repair and/or install the device.



### **CAUTION!**

This **eMC2** charging pole is intended for connection to and operation on 230 / 400 V 50 Hz mains power. The power supply must be inserted into the housing through a suitable cable conduit or tube.

- Use a dry or slightly damp, well-wrung cloth for cleaning the charging pole. Do not use aggressive cleaning agents, waxes or solvents (such as cleaning fluid or paint thinner) because they can dull the displays and damage the paint finish.
- The **eMC2** charging pole must under no circumstances be cleaned with a pressure cleaner or any similar device where liquids hit the surface of the device with high pressure.
- Regularly check the charging sockets and the separately available charging cables of your **eMC2** charging pole for wear and tear. Should any separately available charging cable show signs of damage, please replace it immediately: No further charging processes are permitted in this case.



### **DANGER!**

Should you, after installation, detect any damage to the housing, the charging sockets or their respective charging cables, you must take the charging pole out of operation immediately.

Please contact the service department of **ABL!**

- Relevant local regulations for operating electrical devices always apply.



## Scale drawings and dimensions

The eMC2 charging pole is delivered fully assembled and checked. All dimensions as well as the mounting points are indicated in the scale drawings below.

### Charging pole

Plan and elevation of the eMC2 series incl. EMC9997 plinth (Scale 1:10, all dimensions in mm, plinth not included as standard)

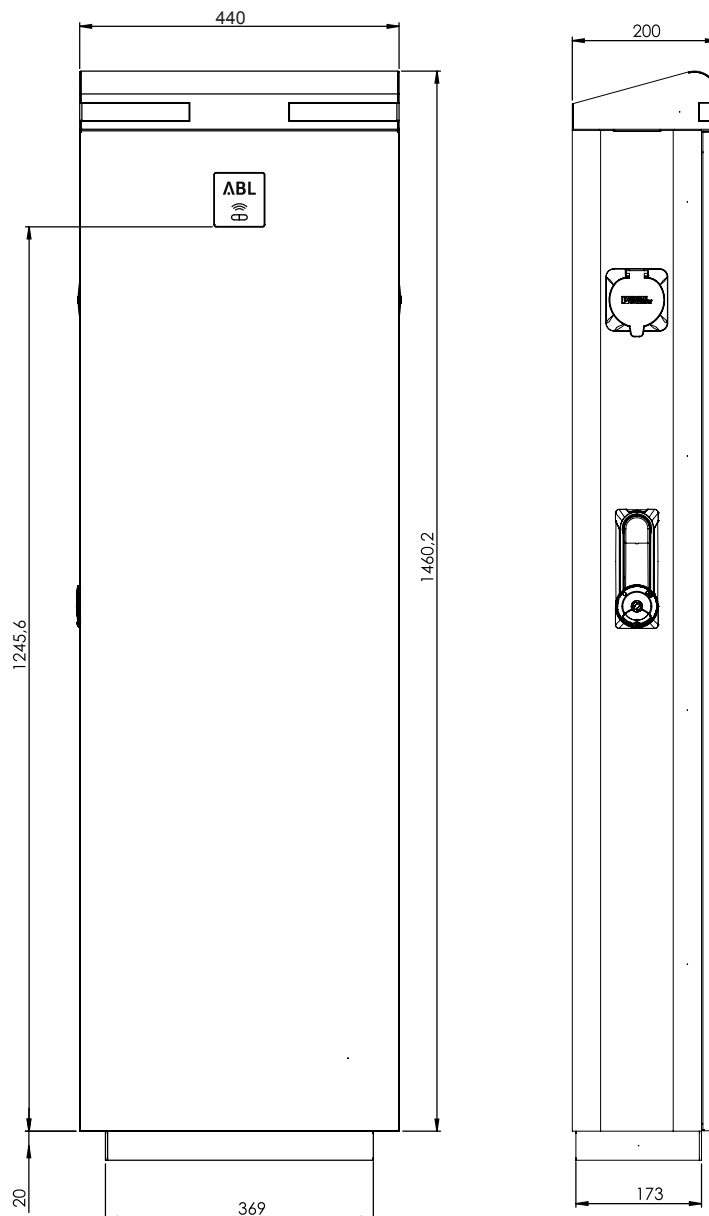

# SCALE DRAWINGS AND DIMENSIONS

## Plinth

For installation of the eMC2 charging pole, ABL offers two separately available plinths: The higher plinth **EMC9998** is intended for installation on a subsurface concrete foundation. For the lower plinth **EMC9997**, the top of the foundation should be flush with the ground level.

Plan and elevations of the plinths (scale 1:5, all dimensions in mm)

EMC9998

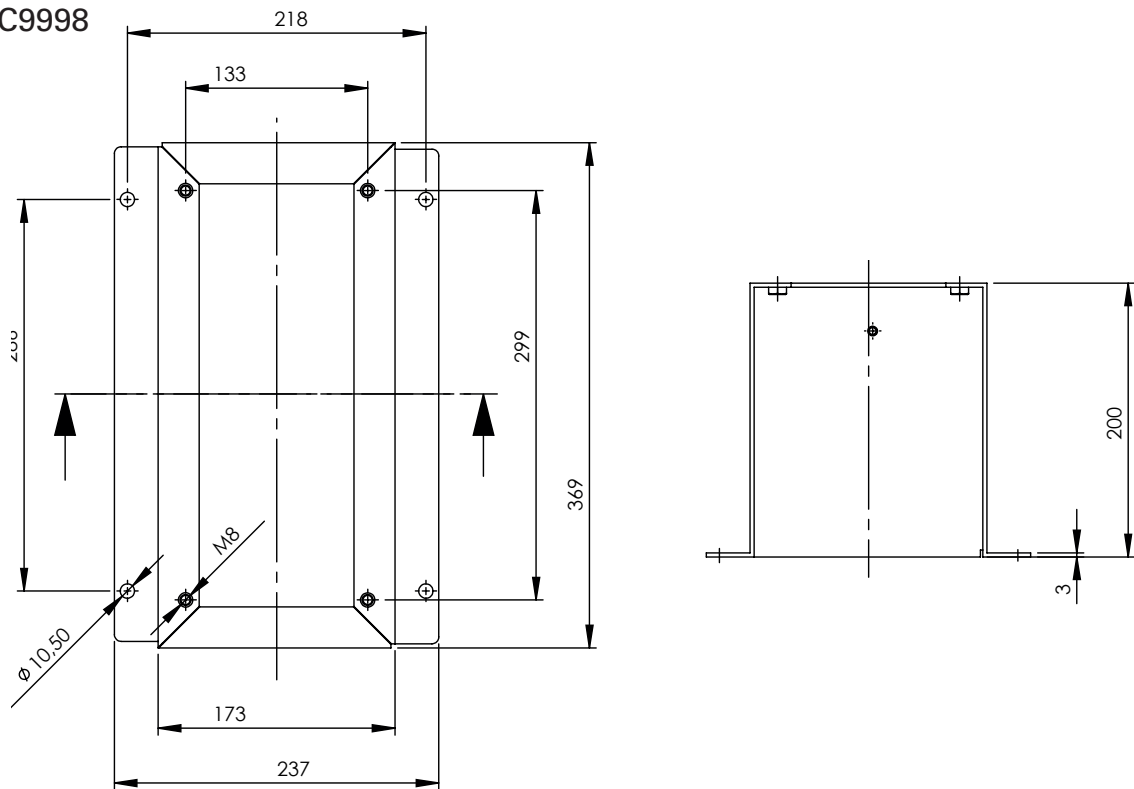

EMC9997

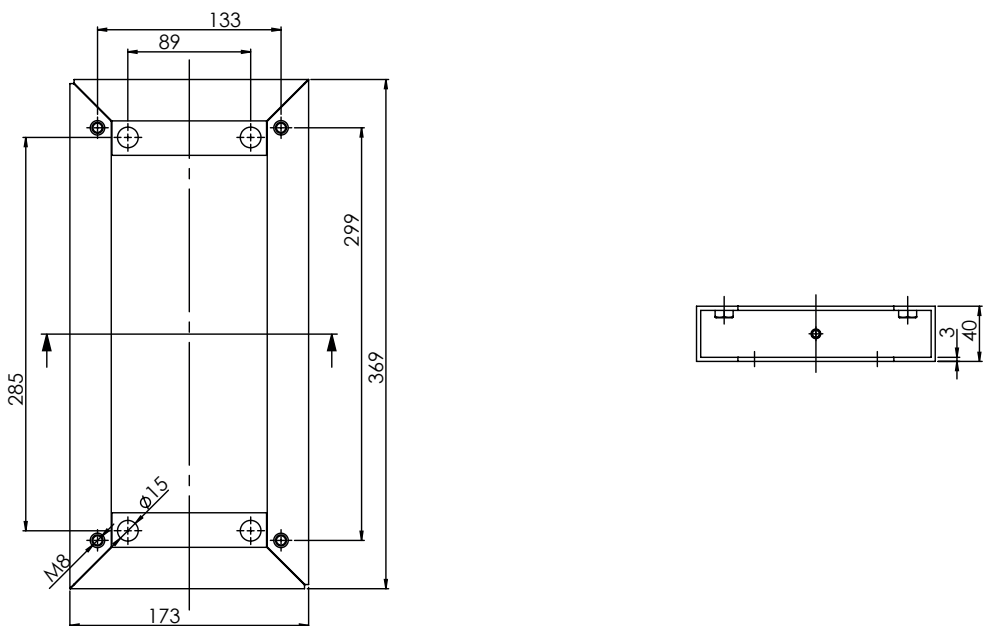

## Foundations

For ground installation, **ABL** offers the **EMC9999** precast foundation block, which provides the necessary stability and security for the charging pole and has an integrated tube to protect the power supply. The foundation block is made from grade C 30/37 concrete and complies with exposure classes XC4, XF1 and WF.

The dimensions of the separately available foundation block are given at the scale of 1:8 (all dimensions in mm). Should you wish to lay your own foundation for the **eMC2** charging pole, you must consider the requirements listed on page 33.

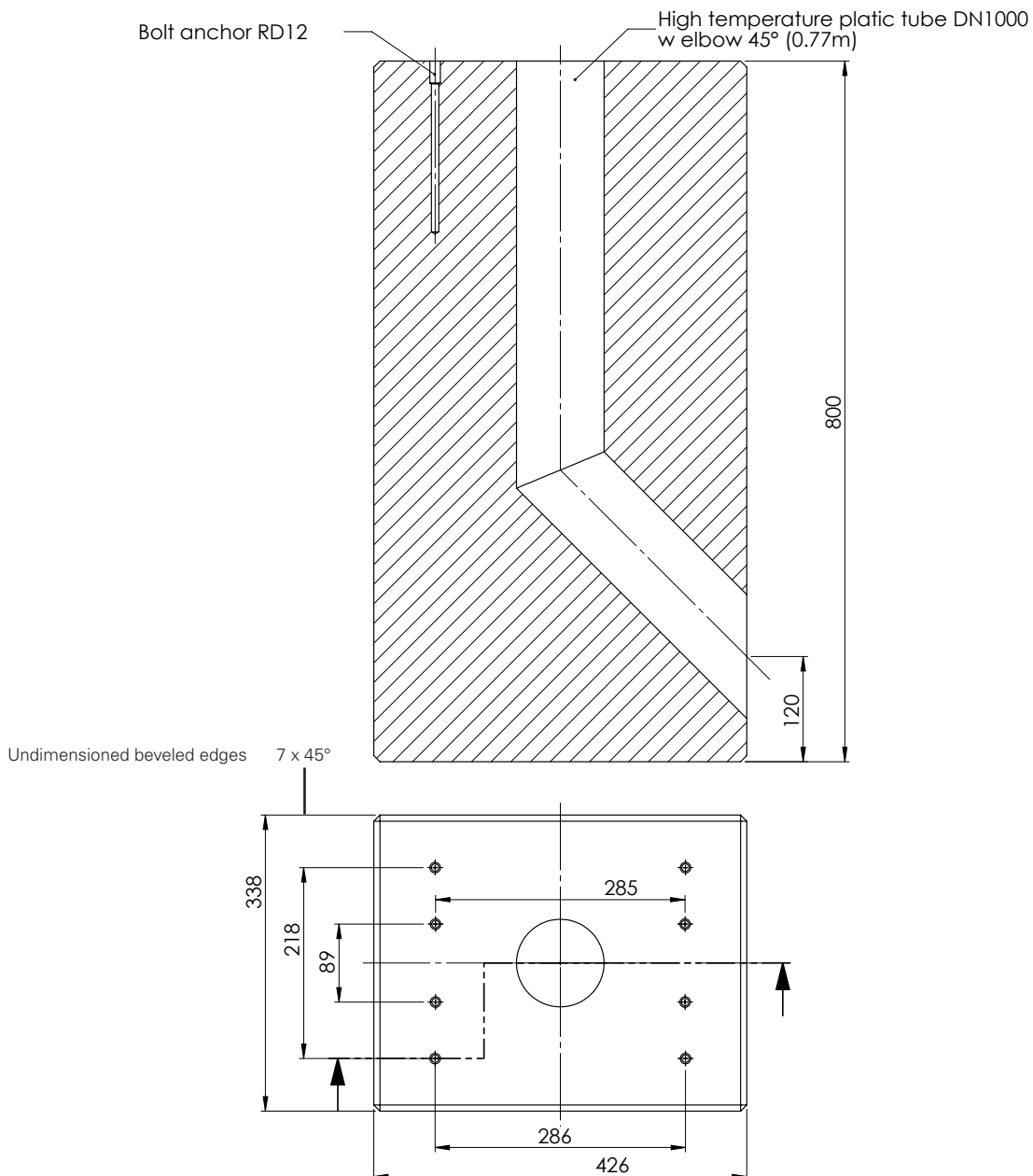

# Introduction

Thank you for choosing the **eMC2** charging pole by **ABL**! With this charging pole from our 'electric **M**obility **C**ity' series, you are investing in an innovative and future-proof solution for public and industrial applications.

The **eMC** series charging poles are delivered pre-configured and, on a well prepared site, can be installed with minimal technical input and in a short time. For particularly fast and easy installation, **ABL** offers a matching, precast foundation block, which is designed especially for installing the **eMC2** and can be ordered separately.

Using the energy management module, the **eMC2** can be integrated into an existing photovoltaic system. When operated as part of a grid connection, the pole can then use 100% solar electricity for charging.

Thanks to controlled access via an internal RFID module, charging processes can be administered and controlled efficiently, while the integrated energy meters take care of the exact measurement of electricity consumption: The data collected can then be made available to external applications on a Smartphone, tablet or PC in real time.

The **eMC2** series charging poles are constantly developed further and at all times comply with all regulations and norms for the charging of electric vehicles applicable throughout Europe according to IEC 61851-1, Mode 3. Please also see the section on "Standards & guidelines" on page 31.

If you are looking for additional information about your charging pole or would like to find out more about available accessories and the rest of the **ABL** product range, please visit our website at **[www.abl.de](http://www.abl.de)**

## Product description

Your **eMC2** charging pole allows you to comfortably and safely charge electric vehicles according to IEC 61851-1, Mode 3. Depending on the model variant, the switching circuits, cable dimensions and connectors of the **eMC2** are engineered to offer the shortest possible charging times for electric vehicles.

The **eMC2** does not have an integrated charging cable but instead features two charging sockets according to IEC 62196-2, Type 2. For these charging sockets, **ABL** offers you two separately available charging cables configured alternatively with Type 2 only or with mixed (Type 2 to Type 1) charging connectors. The **eMC2** is also available with SCHUKO sockets: You can obtain further information from your distributor.

We place the highest value on user safety in all our products. This is why the **eMC2** charging pole also features, in addition to internal safety switches, residual current circuit breakers, which, in combination with the protective measures that are part of onsite electrical installations, offer effective protection from short circuit, electric shock and other operational hazards. Access to the internal switching devices is controlled via the flip-out handle at the side of the charging pole so that only authorized users can open the charging pole.

**PLEASE NOTE:**

A locking cylinder for the double-cylinder flip-out handle is NOT pre-installed by the factory. A suitable size 40 or 45 Euro profile half cylinder lock must be obtained from a specialist supplier and installed in the flip-out handle according to the respective manufacturer's instructions. The screws needed for installation are included with the **eMC2**. It is strongly recommended never to operate the **eMC2** in a public area without installing a cylinder lock.

Users are at all times informed about the current status of the charging pole and the charging status of the connected electric vehicle via the two status lights at the upper edge of the housing as well as the LEDs for charging login and authorization located in the central control panel. Should a malfunction occur during operation or login, the cause is indicated here or by the LEDs above the charging sockets: You can find a list of possible faults as well as suitable suggestions to resolve them in section "Operational disruptions and solutions" on page 28.

The sturdy housing of the **eMC2** is prepared for protection rating IP44 and can be installed on a suitable outdoor installation site using a concrete foundation laid by the user or separately available from **ABL**. You can find detailed information for assembly and installation in Chapter "Preparing for installation" from page 13.

## Identifying your product variant

The **eMC2** series comprises several model variants that differ in terms of charging sockets and/or charging capacity and therefore suit different applications. A serial plate for identifying the model variant is located on the inside of the housing cover: Before installing and taking the charging pole into operation, open the housing cover and double check the model variant on the serial plate.



**PLEASE NOTE:**

Mechanical installation is identical for all **eMC2** model variants. Variations in the steps for electrical installation only arise from the integration of separately available modules (e.g. photovoltaic system or load management module, if supported).

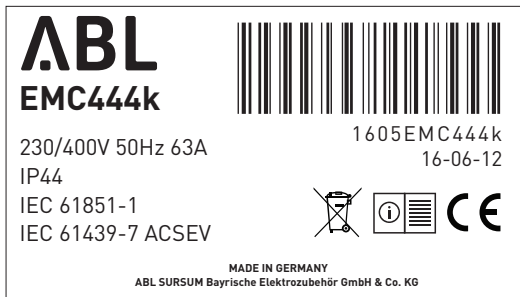

For identification, the model code (EMC XXXX) as well as the power supply ratings (voltage, frequency, current) indicated below it are especially relevant.

If the charging pole includes an internal GSM ready component, its respective CEXXXX Notified Body identifier is indicated on the serial plate.

You can find detailed information on the **eMC2** charging poles in section “Specifications” on page 30.

**Includes**



Your **eMC2** charging pole comes with a range of components, which are necessary for the proper installation and operation of the device. Therefore, please check immediately after unpacking whether the following basic components are included:



<b>Component</b>	<b>Quantity</b>	<b>Description</b>
eMC2 charging pole	1	Charging pole, consisting of metal housing with lockable cover
Installation and User Manual	1	Instructions for mechanical and electrical installation as well as for taking the charging pole into operation (this document)
Wiring diagram	1	Schematic of the supply connections and wiring up of internal electronics
Sealing profile	1	Metal profile for sealing the gap between plinth and pole with sealing tape
Installation kit	1	Blind cylinder including two M4 x 16 countersunk head screws for installing a separately available locking cylinder in the flip-out handle.
Inspection report	1	Report of the factory based operational test

Should one or more components be missing after unpacking, please contact your local distributor immediately: You can find the necessary contact details on page ii in this manual.

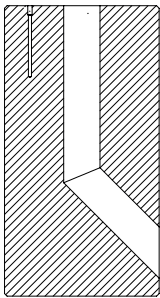
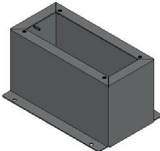
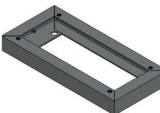
## Available accessories

ABL offers the following accessories for the eMC2 charging pole:

	Designation	Model number	Quantity
	<p><b>Concrete foundation block</b> for the secure installation of the charging pole using the four hexagonal head bolts and internal RD12 bolt anchors included, concrete grade C30/37 (XC4/XF1/WF), power supply via integrated high temperature plastic tube, incl. 2 lifting anchors L x W x D: 426 x 338 x 800 mm</p>	<b>EMC9999</b>	<b>1</b>
	<p><b>Plinth 200</b> Metal plinth, high version, for installing the charging pole on the separately available concrete foundation block using the four screws included, L x W x D: 369 x 237 x 200 mm</p>	<b>EMC9998</b>	<b>1</b>
	<p><b>Plinth 40</b> Metal plinth, low version, for installing the charging pole on the separately available concrete foundation block using the four screws included, L x W x D: 369 x 173 x 40 mm</p>	<b>EMC9997</b>	<b>1</b>
	<p><b>Type 2 charging cable</b> for connection with all eMC2 charging poles and vehicles with charging sockets according to IEC 62196-2, Type 2, 32 A 240 / 415 V AC and IP44 splash protection rating Length: 4 meters</p>	<b>LAK32A3</b>	<b>1</b>
	<p><b>Adapter cable Type 2 to Type 1</b> for connection to all eMC2 charging poles with charging sockets according to IEC 62196-2, Type 2, with charging connector according to IEC 62196-2, Type 1, 32 A 230 V AC, and IP44 splash protection rating Length: 4 meters</p>	<b>LAKT2T1</b>	<b>1</b>

	Designation	Model number	Quantity
	<p><b>eCB1 LAN Module</b> Load management module, 3-phase effective power energy meter up to 63 A, with RS 485 LAN interface</p>	<p>LAST2LR LAST1LR</p>	<p>1 1</p>
	<p><b>eCB1 WLAN Module</b> Photovoltaics management module, 3-phase effective power energy meter up to 63 A, with RS485 WLAN and LAN interface</p>	<p>PV10LWR LAST1LR</p>	<p>1 1</p>
	<p><b>Surge protector</b> for 3-phase power supplies with separate N und PE (5 wire system: L1, L2, L3, N, PE), with remote signaling device</p>	<p>on request</p>	<p>1</p>



**PLEASE NOTE:**

Depending on your order, a range of accessory components may already be preinstalled in the eMC2.

Please contact your local distributor if you require additional information about these accessory components or would like to place an order.

Please also visit our website at [www.abl.de](http://www.abl.de)  
You will find further information about our products and our entire product range there.



**CAUTION!**

Please note that self-installation of optional integrated components (LAST2LR/1LR, PV10LWR) is not permitted: Please contact a qualified contractor or arrange installation with your local distributor.



# Preparing for installation

To install the **eMC2** charging station, a range of prerequisites regarding the site and power connections must be met in order to guarantee safe operation.

## Requirements for the installation site

The **eMC2** charging pole was developed for indoor and outdoor applications. To ensure a proper charging process, you as operator must comply with the following instructions regarding site and installation.

- Consider all local regulations for electrical installations, fire protection and accident prevention.
- All rules for low voltage installations according to IEC 60364-1 and IEC 60364-5-52 apply.
- The installation surface must have sufficient strength to withstand the mechanical stresses.
- It is recommended not to install the **eMC2** directly on a blacktop or concrete floor, but to use a concrete foundation of suitable specifications (see **EMC9999**).
- A sufficiently dimensioned cable for the power supply must be planned for the installation site. The power supply must be positioned in the ground in relation to the tube opening in the concrete foundation. In the vicinity of the foundation, the power supply must, if necessary, be protected against mechanical impact (using a suitable hose or tube).
- The ground at the installation site must allow the drainage of liquids that may have entered the plinth.
- Protection against mechanical impact should include site-specific guards to prevent potential collisions of electric vehicles with the charging pole.
- An electric vehicle parking spot must be planned for on both sides of the charging pole. The minimum distance between vehicle and charging pole should be no less than 50 cm and no more than 150 cm.
- Select an installation site for the charging pole that is easily accessible to emergency services vehicles.
- The **eMC2** charging pole should not be installed in areas with high pedestrian or vehicle through-traffic. Please make sure especially that the charging cables are clearly visible and that passers-by or pedestrian pathways are not obstructed by the cables.
- In general, the **eMC2** is engineered for operation in high ambient temperatures. However, it must be ensured that the maximum operating temperature is not exceeded through external influences such as direct sunlight or similar. If required, make contact with your local service partner and make an appointment for advice.

## PREPARING FOR INSTALLATION



### **CAUTION!**

Connecting the power supply to the domestic power distribution box (rendered non-live by the operator of the distribution network) is carried out by a qualified electrical contractor after installation and before it is taken in into operation.



### **DANGER!**

The power supply must be non-live at all times during the preparation of the foundation described in the following: The power supply must only become live after installation is completed. Violation of this rule results in danger of lethal electric shock!

### **Preparing for and setting the separately available foundation block**

For the safe and proper installation of the eMC2 charging pole, ABL offers the separately available **EMC9999** concrete foundation block, which provides a level installation surface and factory installed bolt anchors for M 12 x 20 hexagonal bolts (included), ensuring a high level of stability. In combination with the separately available **EMC 9998** and **EMC9997** plinths, the foundation block can be installed either subsurface or flush with the ground level at the installation site.

Please proceed as follows to lay down the separately available **EMC9999** foundation block for installation of the charging pole:

1. After selecting an appropriate site (see previous section), a pit to suit the foundation block must be excavated. Please consider the dimensions of the foundation block (L x W x D: 426 x 338 x 800 mm), sufficient working space and, if necessary, a slope angle.



### **PLEASE NOTE:**

If you are using the separately available **EMC9997** low plinth, the foundation block is to be set flush with the ground surface.

If you are using the separately available **EMC9998** high plinth, you can set the foundation block at a depth of between 800 and 960 mm below ground level. Please consider installation depth when excavating.

2. Bring the foundation block into position inside the excavated pit. Ensure that the power supply meets the tube set into the foundation block for it. Protect the power supply in the area near the foundation block with a suitable hose or tube if necessary.
3. Insert the non-live power supply into the opening of the tube in the foundation block and ensure that cables protrude sufficiently or can be pushed out further in order to carry out electrical connection without any problems.

4. When the foundation block has been brought into position, adjusted with a spirit level and the necessary power supply cables have been inserted, you can refill the excavated pit and compact the fill.

### **Foundations laid by the operator**

Alternatively, the operator may construct a foundation allowing for a similarly secure and durable attachment of the charging pole. In this case, the specifications listed on page 33 must be followed.

Proceed as follows to construct a foundation for installing the **eMC2**:

1. After selecting a suitable installation site (see page 13), excavate a sufficiently large pit. Select dimensions ensuring stability in all directions and the secure installation of the **eMC2** using one of the separately available plinths.
2. Construct the formwork (e.g. lost formwork).
3. Place an empty tube inside and insert the non-live power supply. If possible, fix the tube into place in such a way that the power supply can be easily inserted into the charging pole via the separately available plinth.
4. Seal the openings of the tube so that no moisture can enter.
5. Pour the foundation using grade C30/37 concrete.
6. Allow the concrete to cure completely before beginning with the installation of the charging pole.



#### **CAUTION!**

In case of concrete foundations poured on site, calculations, design and construction are the sole responsibility of the operator or the company contracted by the operator to carry out the installation.

# Installing the charging pole

After laying the foundation, mechanical as well as electrical installation of your **eMC2** charging pole can be carried out and it can then be taken into operation. In principle, installation should be carried out by qualified personnel. Inspection before taking the charging pole into operation must always be carried out by a qualified electrical contractor.

Your **eMC2** charging pole is an electrical device and is therefore subject to particular prerequisites for indoor and outdoor installation: Although the housing of the **eMC2** complies with the standards for the IP44 degree of protection, you must take into account certain environmental conditions, especially outdoors.

- For the safe operation of your charging pole, minimum distances to other technical installations must be observed: You can obtain further information from your electrical contractor or your distributor.
- The charging pole must be installed where it is freely accessible to all authorized users.
- Choose an installation site that allows you to reach the charging socket of your vehicle comfortably with the charging cable separately available for the **eMC2**: The cable must not under any circumstances be strained when connected to the vehicle.

## Delivery and transport

The **eMC2** is preassembled at the factory and is delivered to the customer in mechanically and electrically faultless condition. During transport, the **eMC2** is protected from damage by special packaging. Should the charging pole show visible damage or malfunctions when it is unpacked at the installation site, please contact the responsible transport company to clarify any questions of liability.



### **PLEASE NOTE:**

**ABL** guarantees the proper operation of the product after delivery and installation within the applicable legal guarantee provisions. This guarantee is limited to damage that can be shown to have resulted from normal use and obvious material or manufacturing defects.

Always make sure to keep the original packaging! In case of damage that cannot be resolved on site, the **eMC2** must be demounted and sent to the manufacturer for repair. The following conditions must be met for appropriate return transport:

- For transport, the **eMC2** charging station must be protected from mechanical damage by the original or other packaging.

- For safe return, transporting the pole fixed to a pallet is recommended.
- Please note that the transport weight of the **eMC2** charging station including all packaging materials may necessitate the use of a forklift.

### **Mechanical installation on the EMC9999 foundation block**

For installation described as follows, the separately available **EMC9998** or **EMC9997** plinths are required. For installation on the **EMC9999** foundation block you will need the following components:

- Four M12 x 20 stainless steel hexagonal head bolts for fixing the plinth to the foundation block (included with the foundation block)
- Four washers for M12 x 20 hexagonal head bolts, minimum external diameter 37 mm, (included with the foundation block)
- Torque wrench suitable for M12 x 20 hexagonal head bolts (size 18/19 mm, not included)
- Spirit level if required (not included)



#### **DANGER!**

During the entire installation process, the safety switches for all supply cables to the **eMC2** must be deactivated: Supply cables must under all circumstances be non-live and may only be reconnected to the electricity grid for taking the device into electrical operation at the conclusion of the installation process.

1. Thread the power supply through the central opening in the plinth. Ensure that the supply cable protrudes sufficiently (> 50 cm) from the high temperature plastic tube in the foundation block.
2. Position the four fixing holes in the base plate of the plinth above the threaded anchors in the foundation.
  - If you are using the **EMC9998** plinth, select the outer openings, which are 218 mm apart (widthwise).
  - If you are using the **EMC9997** plinth, select the inner openings, which are 89 mm apart (widthwise).
3. Insert the four included M12 x 20 bolts through the matching washers and the openings in the plinth into the threaded anchors in the foundation block and tighten them using the torque wrench. For the prescribed strength grade 8.8, the tightening torque should be 35 Nm.

## Mechanical installation of the plinth on alternative surfaces

In principle, **ABL** can only guarantee sufficient stability of the **eMC2** when properly installed on the separately available **EMC9999** foundation block.



### **DANGER!**

For installations carried out on a concrete floor or foundation poured on site there is a danger that high lateral forces will tear the **eMC2** from the ground.

The following description of installation is intended as an example and uses Würth W-SA Ø 14 mm zinc plated steel bolt anchors to screw the **eMC2** to a concrete substrate complying with the specifications provided on page 33. Always select this or another fixing method of equal mechanical strength!

For installation you will need the following components:

- **EMC9998** or **EMC9997** plinths (available separately)
- Four Würth DBL(W-SA/S)-SW21-(A2K)-15-14x110 bolt anchors with large washers (not included)
- Impact drill (not included)
- Drill bit for up to grade C50/60 concrete, matching Würth W-SA Ø 14 mm bolts (not included, further information about fixings can be obtained from the manufacturer at [www.wuerth.de](http://www.wuerth.de))
- Torque wrench suitable for W-SA Ø 14 mm hexagonal heads (size 21 mm, not included)
- Drilling template for the **eMC2** (included)



### **DANGER!**

During the entire installation process, the safety switches for all supply cables to the **eMC2** must be deactivated: Supply cables must under all circumstances be non-live and may only be reconnected to the electricity grid for taking the device into electrical operation at the conclusion of the installation process.

1. Use the drilling template to mark the four drilling holes at the installation site for installing the plinth. Ensure that the supply cable is in the middle of the central opening of the plinth.
  - If you are using the **EMC9998** plinth, mark the drill holes with a distance of 218 mm (widthwise) and 285 mm (lengthwise).
  - If you are using the **EMC9997** plinth, mark the drill holes with a distance of 89 mm (widthwise) and 285 mm (lengthwise).
2. Drill the fixing holes according to the manufacturer's specifications for the recommended Würth W-SA Ø 14 mm bolt anchors.
3. Clean the drill holes: For high strength, the drill holes should be as dust free as possible.

4. Insert the power supply through the central opening in the plinth and position the four screw holes in the base plate of the plinth above the drill holes.
5. Insert the bolt anchors with washers into the drill holes and tighten them using the torque wrench.



### **CAUTION!**

Ensure that the supply cable is non-live and protrudes sufficiently (> 50 cm) from the high temperature plastic tube inside the foundation.

### **Mechanical installation of the charging pole on the plinth**

At least two persons are required for the next steps in the installation of the charging pole. You will also need the following components:

- Fork wrench or equivalent for M8 bolts, size 13/14 mm (not included)
- Spirit level if required (not included)

Proceed as follows:

1. Open the housing cover of the charging pole by unlocking the flip out handle on left side of the **eMC2** using the temporary key included.
2. Bring the charging pole into position above the installed plinth. Insert the power supply into the cable opening in the base of the charging pole.
3. Position the charging pole on the plinth so that the screw holes in the base plate of the charging pole are directly above the openings in the top plate of the plinth.
4. Stick the included sealing tape across the upper rim of the plinth, exactly between the screw openings in the front part of the pole.
5. Apply the sealing profile included and position it so that the screw holes are directly above the openings in the base plate of the charging pole and the openings in the top plate of the plinth.
6. Using the fork wrench and the four M8 x 20 hexagonal head bolts included, fix the sealing profile hand-tight to the charging pole and the plinth.

This step concludes mechanical installation of the charging pole. However, it is recommended to use this opportunity to install a commercially available profile cylinder lock in the flip out handle of the **eMC2**: Installation will be described in the instructions for the cylinder lock, but please use the two M4 x 16 countersunk head bolts included to secure the lock in the flip out handle.



### **PLEASE NOTE:**

To dehumidify the interior space of the **eMC2**, we recommend to fill the entire plinth area with a granulated desiccant: This serves to minimize the unwanted effects of condensation and water seepage.

### Electrical installation of the charging pole

The following is a description of connecting the power supply inside the eMC444K charging pole: Installation and connection of accessory components are not subjects of this manual, but are described in the documentation for the components.



**DANGER!**

To exclude the danger of electric shock during electrical installation, you must ensure that the power supply is definitely non-live.

For electric installation you will need the following components:

- Flat head screwdriver, 8 mm minimum blade width (not included)
- 4 mm hex key (not included)
- Suitable NH fuses (not included)

Proceed as follows to connect the charging pole to the electricity grid:

1. Double check that all safety switches and, if present, RCCBs in the power supply are deactivated.
2. Now switch off all internal safety switches and RCCBs inside the charging pole (0 OFF).
3. Open the domestic fuse box located in the lower part of the pole using the flat head screwdriver and flip the housing cover down.
4. Remove the VNB cover.
5. Insert the stripped wires of the power supply into the box from underneath.
6. Insert the individual wires into the marked terminal blocks inside the box. The terminals are marked to avoid miswiring.

Designation	Power supply cable wire color	Terminal marking
Current-carrying conductor phase 1	Black	EUROFUSE NH00/000 63 A
Current-carrying conductor phase 2	Black	EUROFUSE NH00/000 63 A
Current-carrying conductor phase 3	Black	EUROFUSE NH00/000 63 A
Protective earth	Green-yellow	Green-yellow grounding



**DANGER!**

The above color-coding is NOT internationally standardized: Should the individual wires in the power supply cable be color-coded differently, please contact a qualified electrical contractor! Have the power supply checked and replaced if necessary.



7. Fix the wires in the terminals using the hex key.
8. Ensure that all supply wires are properly tightened and are not under strain.
9. Insert the separately available NH fuses.
10. Replace the VBN cover.
11. Close the housing cover using the flat head screwdriver.
12. Switch on all internal safety switches and RCCBs inside the charging pole (**I ON**-position).
13. Close the pole cover and lock it using the flip out handle.



**CAUTION!**

It is recommended for operation that you install a cylinder lock in the flip out handle of the charging pole to prevent any unauthorized opening of the housing. Commercially available size 40 or 45 half profile cylinders are suitable for this purpose.



**PLEASE NOTE:**

The eMC445K charging pole has an internal terminal block for connection to the electricity grid: The terminals are marked unequivocally and the power supply can be screwed directly to the terminals using the above table.

After the power supply has been connected inside the charging pole, the NH fuses for the power supply can be put back by the power distribution network operator. Voltage can then be applied to the charging pole by a qualified electrical contractor and it can be taken into operation.

## Taking into operation and charging procedure

Your charging pole is ready for use immediately after mechanical and electrical installation have been completed. Your **eMC2** provides two Type 2 charging sockets according to IEC 62196-2. Accordingly, you will require separately available charging cables to connect your vehicle. To provide a high level of flexibility, **ABL** has two different cables on offer for this purpose:

Model code	Description	Maximum output
LAK32A3	Type 2 charging cable for connecting all eMC2 charging stations and vehicles with charging sockets according to IEC 62196-2, Type 2	22 kW
LAKT2T1	Adapter cable Type 2 to Type 1 for connection to all eMC2 charging stations with charging sockets according to IEC 62196-2, Type 2, with charging connector according to IEC 62196-2, Type 1	7.4 kW

The Type 2 charging socket of the **eMC2** has three current-carrying contacts, a neutral conductor, a PE-protective earth conductor as well as two signaling contacts (**C**ontrol **P**ilot and **P**roximity **P**ilot), which ensure a secure connection and therefore the safe operation of the charging station.

As long as the plug of the external charging cable is not locked into place in the charging socket of the **eMC2**, no voltage will be applied from the socket to the charging cable via the current-carrying contacts.

The charging socket of the **eMC2** has an integrated electromechanical locking function, which allows totally controlled and therefore user-specific access and monitoring of the charging process using the internal RFID module.

The Type 2 charging sockets of the **eMC2** each have an internal RCCB. This circuit breaker is especially required in cases where your electric vehicle does not provide any DC fault current protection itself: You can find information about this in the manual for your vehicle and from the manufacturer or vehicle dealership.

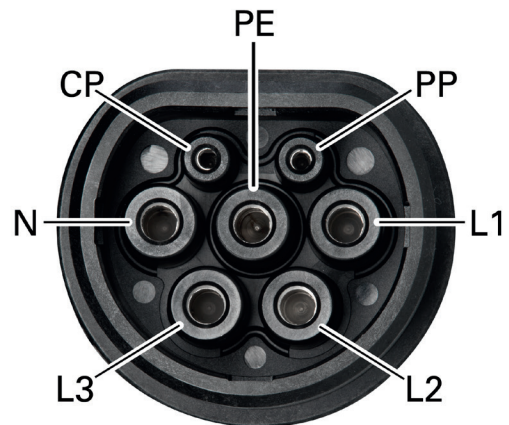

Charging socket Type 2

### Operational safety notices

Before initiating a charging process with your **eMC2**, you must observe the following safety notices:

- Ensure that the **eMC2** has been installed according to the instructions in this document: Check especially that there is free access to the charging pole and that an electric vehicle can be connected without any strain or other encumbrance on the charging cable.
- Ensure that the **eMC2** is properly connected to the power supply.
- Ensure that the power supply is secured by a suitable RCCB.
- Ensure that the door of the **eMC2** is always locked during normal operation.
- Ensure that the external charging cable is not twisted and check that cable, connectors, housing and charging sockets are not visibly damaged.

## Preparing access control via RFID (model variants with RFID module only)

If your **eMC2** model variant has an integrated RFID card reader, you can set up user identification to restrict or allow access to the charging process for a defined use group. Registration at the **eMC2** is via RFID compatible transponders and/or RFID access cards, which you can obtain from the operator of your user portal.

Programming and registration of RFID access are via the central RFID module built into the top section of the **eMC2**. During programming, registration and operation, status and feedback information from the RFID module is displayed by one blue and one green LED.

Before you can carry out a charging process using the **eMC2**, you must register the ID tag cards supplied (or separately obtained) with the RFID module of your charging pole. To do so, proceed as follows:

1. Check the status of the charging pole via the LEDs in the RFID module: When the charging pole is ready for operation, the blue LED will flash every 10 seconds.
2. Hold one of the ID tag cards in front of the module.
  - If the card is already registered, the green LED will flash once and then stay on for a short period. To re-register this card, it must first be erased.
  - If the card has not yet been registered, the blue LED will flash once and then stay on for a short period. This card can now be registered.



flashes every 10 seconds



flashes once



illuminated



flashes once



illuminated

If you have questions or problems with registration, please contact the operator of your user portal.

### Preparing access control via OCPP (EMC444K only)

The EMC444K model variant features a RFID card reader with GSM module for wireless communication with distant user portals or other compatible back end solutions: Communication between charging station and interface operates on the basis of OCPP protocol V 1.5. As a result, charging processes can be restricted or allowed for each user. On the basis of the user and consumption data collected, energy consumption can be calculated accurately and accounted for in relation to each user.

Measuring consumption is carried out via a MID compatible energy meter that is installed in a separate housing under the front cover of the **EMC444K**: The separate housing ensures that the meter is protected according to IP54. Operating the energy meter as well as reading the data collected is described in detail in the instruction manual included with the charging pole.



#### **CAUTION!**

To ensure the proper operation of the device, please note that the factory settings of the energy meter, especially the pre-set address, must not be altered.

Registration of the EMC444K also occurs via RFID compatible transponders and/or RFID access cards in MIFARE® format. Set up and use of the RFID functions of the EMC444K depend directly on the respective user platform and therefore on its operator or service provider: Apart from the required access cards you can also obtain detailed instructions for setting up RFID functions from your service provider.

### Charging procedure

The **eMC2** is engineered for the shortest possible charging times according to IEC 61851-1 Mode 1 (where SCHUKO sockets are used) or IEC 61851-1 Mode 3. The actual charging time depends on the battery fitted to your vehicle as well as on the energy currently remaining in the vehicle. For these reasons it is not possible to make a reliable prediction of the charging time: You will discover its actual value in practice and derive your personal charging routine accordingly.

Please follow the following steps to charge your vehicle:

1. Check the LED status indicator in the top part of the **eMC2**: When the charging pole is ready for operation, the LED strips on either side of the pole will be green.
2. Open the charging socket on the vehicle.
3. Plug the charging connector of the charging cable (Type 2 or Type 1) into the vehicle's charging socket. The vehicle must be positioned so that you can comfortably reach the vehicle socket. The cable must not be strained during the charging process.
4. Open the cover of one of the charging sockets on the **eMC2** and plug in the Type 2 recharge plug.



5. Log in at the RFID module of the **eMC2** using a suitable access card. To do this, hold the card in front of the marked area on the RFID module.

The charging process will only commence when the access card has been identified successfully.

During connection and registration at the charging pole, the LED status indicator for the Type 2 charging socket in use will be permanently green. When the charging process begins, the color of the status indicator will change to blue.



**PLEASE NOTE:**

Should a malfunction occur during or after the charging process, this will be indicated by the LEDs above the respective charging socket. The following chapter describes how you can identify operational states and errors and which measures will become necessary.

When charging is complete, unplug the cable from the vehicle socket and from the socket of the charging pole.

## Resolving errors

Your eMC2 charging pole is engineered for maximum operational safety and the highest possible charging reliability. Internal testing algorithms detect any malfunction of the eMC2 and switch the charging pole off immediately.



Should a malfunction occur in practice, an error code will be shown by the indicator LEDs on the housing and/or the LEDs on the RFID module. The following chapter describes how you recognize operating states as well as error codes and which measures you must take to resolve them.

### Operating states

The LED status indicators of the charging pole indicate the current operating status. To indicate certain operating states, the LEDs may...

- ...be illuminated (continuous ON)
- ... be extinguished (continuous OFF).

During normal operation, the following colors and states of illumination are displayed by the LEDs:

		Description
illuminated	OFF	The charging station is ready for operation, the vehicle may be connected for charging at any time.
OFF	illuminated	The vehicle is currently being charged.



**PLEASE NOTE:**

The charging process is always terminated by the vehicle, not by the charging station. The eMC2 only indicates that you can unplug the charging cable from the vehicle charging socket on the basis of communication with the vehicle. Should the vehicle not be charged sufficiently at this point, please contact your service partner for the vehicle.



In some circumstances, malfunctions and disruptions may occur that prevent the proper charging of the vehicle according to IEC 61851.1, Mode 3. The eMC2 detects any faults occurring on the part of the vehicle and displays them via the LED indicators that are located centrally inside the housing or as part of the RFID module (if present) of the charging pole.

## Operating status (RFID module)

The two central LED indicators also display the current operating status of the internal RFID Module of the charging pole. To indicate certain operating states, the LEDs may...

- ...be illuminated (continuous ON)
- ...flash
- ... be extinguished (continuous OFF).

During normal operation, the following operating states are shown:

		DESCRIPTION
flashes every 5 seconds	OFF	The RFID module is ready for use, a charging process may be requested at any time using an authorized transponder (access card).
flashes for no more than 15 sec.	OFF	The RFID module has read the transponder data and initiated authentication.
illuminated for 1 sec.	OFF	Authentication of the transponder was successful, access to the charging process is being granted.
OFF	illuminated for 1 sec.	Authentication of the transponder was NOT successful, access to the charging process is NOT being granted.



### PLEASE NOTE:

Should the RFID module of the eMC2 refuse authentication of the charging process, this indicates an error within the user data: In this case, please contact the provider of the user platform.







## Error codes for RFID module operation

Under some circumstances, malfunctions and disruptions may occur during or after individual user login at the RFID module that prevent the proper charging of the vehicle according to IEC 61851.1, Mode 3. The eMC2 independently detects any errors during user registration and transmits these as feedback to the user portal via the back end device: In case of an error, please contact the operator of your user platform.

To represent certain errors, the indicator LEDs will flash in a specific pattern that repeats until the error has been resolved.

## RESOLVING ERRORS

The following errors are represented:

LED-SEQUENCE (FLASHING)	ERROR DESCRIPTION
	Transponder authorization is not possible or the system is currently in start-up mode.
	The internal control module returns an error.
	The internal energy meter returns an error.
	The internal GSM module (if present) returns an error.
	An error has occurred during GSM/GPRS data transmission.
	Connection with the user platform cannot be established.

### Operational disruptions and solutions

The **eMC2** runs internal testing algorithms to ensure proper and safe operation. To take suitable measures and restore operation in case of malfunction, you must first clearly identify the type of error.

The following errors may occur:

ERROR	POSSIBLE CAUSE	SUGGESTED SOLUTION
LEDs are not functioning	The <b>eMC2</b> does not have a power supply.	The external power supply for the <b>eMC2</b> is disrupted: Check the upstream circuit breaker. The internal RCCB of the <b>eMC2</b> has been tripped: Check the status of the RCCB and, if necessary, switch it back on using the pivot lever .
	The indicator LEDs of the <b>eMC2</b> are faulty	Should the indicator LEDs of the <b>eMC2</b> be faulty, they must be replaced. In this case, please contact your local distributor.
The electric vehicle is not recognized	The charging cable is not properly plugged into the vehicle	Remove the recharge plug from the vehicle and plug it back in: Ensure that the connector sits properly inside the vehicle socket.
	The vehicle is wrongly configured	Check the vehicle settings and, if necessary, reset them (to factory settings).



The indicator LEDs on the RFID module show an error sequence

The **eMC2** detects a malfunction via the back end device

The **eMC2** reinitiates the charging process every 30 seconds: Should the error persist, please contact your service partner for the vehicle.

All errors indicated by the LEDs on the RFID module relate to the RFID login procedure. Should the error persist, re-register the RFID cards or contact your local distributor.

### Checking the internal RCCB

To ensure the continuing safe operation of the charging station, you must check the function of the integrated residual current circuit breakers (RCCB) yourself every 6 months: Every RCCB has a button with which to initiate the test function.

Proceed as follows to test the RCCB:

1. Open the housing cover of the **eMC2** using the flip out handle.
2. Locate the RCCB: There is a button engraved **T** or marked **Test**.
3. Press the button: The RCCB should now trip and flick the pivot lever of the RCCB into the **0** position (connection to the power supply is interrupted).
4. Switch the RCCB back on by flipping the pivot lever up into the **I** position and close the cover of the **eMC2**.



#### **DANGER!**

Should the RCCB not trip during testing, there is a danger of malfunction: In this case you must under no circumstances continue to operate the charging pole!

Please contact your local distributor from whom you have purchased the charging station.

# Appendix

## Specifications

<b>Model Variant</b>	<b>eMC2 Hightech 22 kW</b>
Power supply	for supply cable sizes of max. 5 x 70 mm <sup>2</sup>
Rated voltage	230 / 400 V
Rated current	63 A, 3 phase
Rated frequency	50 Hz
Max. output	22 kW
Charging sockets	2 x Type 2 32 A
Charge controller	EVCC, 2 pcs.
Access control	RFID Mifare, SMS via backend
Photovoltaics	PV ready
Operating temperature	-30°C to 50°C
Storage temperature	-30°C to 85°C
Max. internal temperature	-30°C to 55°C
Relative humidity	5 to 95% (no condensation)
Class of protection	I
Rated impulse withstand voltage	$U_{imp} = 4 \text{ kV}$
Overvoltage category	III
Rated insulation voltage	$U_i = 300 \text{ V AC}$
Max. ground resistance	10 Ohm (with optional surge protector)
Degree of pollution	3
Degree of protection (housing)	IP44
Degree of protection (energy meter)	IP54
Maximum elevation	≤ 2,000 m above mean sea level
Pole dimensions	1,460 x 440 x 200 mm (H x W x D)
Weight per unit	ca. 44 kg
Model number	EMC444K

<b>Model Variant</b>	<b>eMC2 Hightech 44 kW</b>
Power supply	terminals for supply cable sizes of max. 5 x 70 mm <sup>2</sup>
Rated voltage	230 / 400 V
Rated current	63 A, 3 phase
Rated frequency	50 Hz
Max. output	44 kW
Charging sockets	2 x Type 2 32 A
Charge controller	EVCC, 2 pcs.
Access control	RFID Mifare, SMS via backend
Photovoltaics	PV ready
Operating temperature	-30°C to 50°C
Storage temperature	-30°C to 85°C
Max. internal temperature	-30°C to 55°C
Relative humidity	5 to 95% (no condensation)
Class of protection	I
Rated impulse withstand voltage	$U_{imp} = 4 \text{ kV}$
Overvoltage category	III
Rated insulation voltage	$U_i = 300 \text{ V AC}$
Max. ground resistance	10 Ohm (with optional surge protector)
Degree of pollution	3
Degree of protection (housing)	IP44
Degree of protection (energy meter)	IP54
Pole dimensions	1,460 x 440 x 200 mm (H x W x D)
Maximum elevation	≤ 2,000 m above mean sea level
Weight per unit	ca. 44 kg
Model number	EMC445K

## Standards & guidelines

The eMC2 charging station complies with the following standards and protection ratings:

### General standards

<b>Standard</b>	<b>Description</b>
2004/108/EC	EMC Guideline
2002/95/EC	RoHS Guideline

## APPENDIX

Standard	Description
2002/96/EC	WEEE Guideline
ElektroG	Electrical and Electronic Device Statute

### Device safety standards

Standard	Description
IEC 61851-1 Ed 2.0:2010	Conductive charging systems for electric vehicles – Part 1: General requirements
IEC 61851-22 (69/201/CD)	Conductive charging systems for electric vehicles – Part 22: AC charging poles for electric vehicles
DIN EN 61851-1: 2012-01	Conductive charging systems for electric vehicles – Part 1: General requirements
E DIN EN 61851-22:2011-04	Conductive charging systems for electric vehicles – Part 22: AC charging poles for electric vehicles
HD 60364-7-722:2012	Low voltage installations – Part 7-722: Power supply for electric vehicles

### Classes of protection & Degrees of protection

Class of protection / Degree of protection	Description
	Class of protection I: All electrically conducting parts of the device are connected at low resistance with the protective earth system of the fixed installation
IP 44	Degree of protection of the device (protection against the intrusion of solid particles more than 1 mm in diameter and against splashing water)
IP 54	Degree of protection of the energy meter (protection against touch, dust in harmful quantities and protection from splashing water)

### Trademarks

All trademarks mentioned in this manual including those that may be protected by third parties are, without restriction, subject to the regulations of the respectively applicable trademark law and the property rights of the respective registered owners. All trademarks, trading names or company names marked here as such are or may be trademarks or registered trademarks of their respective owners. All rights not explicitly granted here are reserved.

The absence of an explicit marking of trademarks used in this manual must not lead to the conclusion that a name is free from the rights of third parties.

## Specifications for the foundation

Alternatively to the separately available ABL foundation block, you can manufacture or pour your own foundation based on the dimensions listed in section "Scale drawings and dimensions" from page 5. This foundation should match the following specifications to ensure stability:

<b>Material</b>	Concrete reinforcing steel B500A
<b>Concrete grade</b>	C30/37
<b>Installation surface</b>	ca. 0.28 m <sup>2</sup> or larger
<b>Volume</b>	ca. 0.12 m <sup>3</sup> or more
<b>Weight</b>	ca. 290 kg or more
<b>Surface</b>	Formwork smooth
<b>Exposure class</b>	XC4/XF1, WF
<b>Concrete cover</b>	min. 3.5 cm (top, bottom, sides)
<b>Bolt anchor</b>	RD12, four pieces, min. length 195 mm
<b>Conduit tube</b>	High temperature plastic tube DN70, 1 x elbow 45°, length 50 cm or more

The tube for the power supply must be of sufficient size in order to accommodate potential additional data and/or control cables. Also, the bolt anchors for securing the base plate of the **eMC2** must meet the specifications in order to guarantee the stability of the charging pole.

The positions of the tube conduit and the bolt anchors must exactly match the dimensions in the plan drawing of the **EMC9999** on page 7.



### CAUTION!

Consider leaving the final installation to a qualified and authorized electrical contractor: Should malfunctions occur that can be shown to have resulted from improper mounting and installation, all guarantee and warranty provisions will become void. Proof of proper installation (e.g. by presentation of relevant invoices) must be furnished on request before guarantee and warranty provisions come into effect.

## Warranty and guarantee provisions

ABL provides the legally prescribed guarantee period as well as a warranty of the same duration for the country in which the product was purchased. Should the product be operated in another country, the legal provisions of the country of purchase apply nevertheless: Under no circumstances are guarantees or the warranty transferable.

Should modifications of any kind have been made to the product that have not been explicitly authorized by ABL or described in the guidelines for authorized service partners, the manufacturer's warranty obligations become void with immediate effect.

On site repairs may only be carried out by the manufacturer. In case of disregard of this provision, all guarantee and warranty provisions become void with immediate effect.



### **CAUTION!**

Should problems occur when operating your product, please contact your local distributor immediately and clarify whether the malfunction is covered by guarantee or warranty provisions.

Do not under any circumstances make alterations or repairs to your product yourself!

**ABL** guarantees the proper operation of the product after delivery within the applicable legal guarantee provisions. This guarantee is limited to damage that can be shown to have resulted from normal use and obvious material or manufacturing defects. In such cases the manufacturer, in collaboration with the local distributor, will attempt to restore the proper functioning of the product. The customer will be responsible for covering any arising transport costs.

However, the manufacturer further rejects any damage claims that can be shown to have resulted from improper use, neglect or modifications, from repair attempts by unauthorized persons or force majeure.

Any assumed guarantees, including a guarantee of marketability or suitability for specific uses are restricted to the warranty period.

## **Intellectual Property & Copyright**

Copyright © 2017

Version 1.2, current revision 2017/07/27

All rights reserved.

Any information in this document may be changed without prior notice and does not represent any obligation on the part of the manufacturer. Illustrations in this manual may show designs different from the delivered product and do not represent any obligation on the part of the manufacturer. The manufacturer does not take responsibility for any loss and/or damages that occur because of the data or possible misinformation contained in these instructions. This manual, in its entirety or in parts, must not be reproduced, stored electronically or otherwise transmitted electronically, electrically, mechanically, optically, chemically, by photocopy or as an audio recording without the written permission of the manufacturer.

## Glossary & Definitions

This table lists and explains important abbreviations from the wider eMobility area.

Abbreviation	Description	Meaning
BEV	<b>B</b> attery <b>E</b> lectric <b>V</b> ehicle	Electric vehicle (100% electric use)
DC-RCM	<b>D</b> irect <b>C</b> urrent <b>R</b> esidual <b>C</b> urrent <b>M</b> onitor	Monitoring device for detecting DC fault currents
GID	<b>G</b> roup <b>I</b> Dentifier	Modifiable group identifier (ABL format)
GSM	<b>G</b> lobal <b>S</b> ystem for <b>M</b> obile Communications	Standard for fully digital mobile networks
HEV	<b>H</b> ybrid <b>E</b> lectric <b>V</b> ehicle	Hybrid vehicle (combination of a classic combustion engine and an electric motor with kinetic energy recovery system)
LED	<b>L</b> ight <b>E</b> mitting <b>D</b> iode	Light-emitting diode
MCB	<b>M</b> iniature <b>C</b> ircuit <b>B</b> reaker	Residual current circuit breaker
OCPP	<b>O</b> pen <b>C</b> harge <b>P</b> oint <b>P</b> rotocol	Communication protocol between charging station and service providers (platform-dependent)
PHEV	<b>P</b> lug- <b>I</b> n <b>H</b> ybrid <b>E</b> lectric <b>V</b> ehicle	Plug-in hybrid vehicle (combination of classic combustion engine and electric motor)
RCCB	<b>R</b> esidual <b>C</b> urrent operated <b>C</b> ircuit- <b>B</b> reaker	FI residual current circuit breaker
RCD	<b>R</b> esidual <b>C</b> urrent protective <b>D</b> evice	FI residual current circuit breaker
RCM	<b>R</b> esidual <b>C</b> urrent <b>M</b> onitor	Monitoring device for the detection of fault currents of a critical value
REEV	<b>R</b> ange <b>E</b> xtended <b>E</b> lectric <b>V</b> ehicle	Electric vehicle with range extension (using a small combustion engine or a fuel cell)
RFID	<b>R</b> adio <b>F</b> requency <b>I</b> Dentification	Identification using electromagnetic waves
UID	<b>U</b> nique <b>I</b> Dentifier	Non-modifiable unique identifier

## Disposal advice

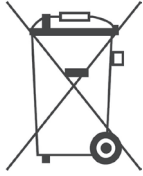

The crossed out trash can symbol indicates that electrical and electronic devices including accessories must be disposed of separate from household trash.

The materials are recyclable as marked. By re-using, recycling or through other forms of use of obsolete devices you make an important contribution to environmental protection.



## CE certification and declaration of compliance



The eMC2 series charging poles carry the CE mark. A copy of the declaration of compliance is printed below and also available from ABL Sursum Bayerische Elektrozubehör GmbH & Co. KG upon request.

### ZERTIFIKAT / CERTIFICATE

**ABL**

#### CE - KONFORMITÄTSERKLÄRUNG CE - DECLARATION OF CONFORMITY

<b>Name des Herstellers Name of manufacturer</b>	ABL SURSUM Bayerische Elektrozubehör GmbH & Co. KG Ottensooserstr. 22 91207 Lauf an der Pegnitz, Germany
<b>erklärt, dass das Produkt declares that the product</b>	Ladesäule eMC2
<b>Type-Nr. Ref. No.</b>	EMC444K
<b>die Forderungen folgender europäischer Richtlinien erfüllt: is in conformity with the following European Directives:</b>	<input checked="" type="checkbox"/> Niederspannungsrichtlinie/Low Voltage Directive 2006/95/EC <input checked="" type="checkbox"/> EMV Richtlinie / EMC Directive 2004/108/EC <input type="checkbox"/> <input type="checkbox"/>
<b>Angewendete (harmonisierte) Normen: Applied (harmonized) standards:</b>	DIN EN 61851:2012 IEC 61851-22 ed. 2.0 (69/201/CD) EN 55011 EN 61000-6-2/3, EN 61000-3-11, EN 61000-3-12 EN 61000-4-11 DIN IEC/TS 61439-7:2014
<b>Jahr der Anbringung der CE-Kennzeichnung: Year of declaration:</b>	2015

ABL SURSUM GmbH & Co.KG Lauf / Pegnitz  
Lauf / Pegnitz

22.09.2015

Datum  
Date

Unterschrift  
Signature

ppa.Udo Pech  
Leiter R & D

Diese Erklärung bescheinigt die Übereinstimmung mit den genannten Richtlinien und beinhaltet jedoch keine Zusicherung von Eigenschaften.  
This declaration certifies the conformity to the specified directives but contains no assurance of properties.

#### ABL SURSUM

Bayerische Elektrozubehör GmbH & Co. KG  
Geschäftsführer Dr. Stefan Schlutius  
Ust.-IdNr.: DE 132 809 180  
Registergericht Nürnberg HRA 6778  
ILN 40 11721 00000 8

Komplementär ABL SURSUM  
Bayerische Elektrozubehör Verwaltungs-GmbH  
Registergericht Nürnberg HRB 4335

Ottensooser Straße 22  
91207 Lauf/Pegnitz  
www.abl-sursum.com

Telefon 09123 188 0  
Fax 09123 188 188  
info@abl-sursum.com

## APPENDIX



