

eMH2 Wallbox

Installation Manual

CONTENTS

Safety first

1. Safety information	3
-----------------------	---

Introduction

2. Components included	13
3. Your Wallbox	14

Installation

4. Preparations	22
5. Mechanical installation	23
6. Electrical installation	27
7. Master / Slave system	32
8. Taking into operation	40

Configuration

9. Configuring EVCC, RFID and energy meter	43
--	----

Appendix

10. Glossary	48
11. Technical specifications	49
12. Dimensioned drawings	58
13. Standards and guidelines	62
14. CE certification and compliance declaration	63
15. Trademarks	64
16. Warranty and guarantee provisions	65
17. Intellectual property & copyright	67
18. Disposal advice	68

Contact	69
----------------	-----------

1. SAFETY INFORMATION



- Sections marked with this symbol draw attention to electrical voltages that represent a danger to life and limb: Actions contrary to these safety notices may lead to severe or fatal injury
- Actions marked with this symbol must not be carried out under any circumstances
- Sections marked with this symbol draw attention to further hazards that may lead to damage to the Wallbox itself or to other electrical devices
- Actions marked with this symbol must be carried out with special care
- Sections marked with this symbol draw attention to further important information and special features that are necessary for the reliable operation of the device
- Actions marked with this symbol should be carried out as required

1. SAFETY INFORMATION



- You must read the installation manual before opening the electronic components cover
- You must read the operating manual before opening the housing cover
- You must heed all warnings and follow all instructions and safety notices
- Persons with limited physical, sensory or mental abilities must use the Wallbox only if they are supervised and under instruction

1. SAFETY INFORMATION



- After opening the housing, dangerous voltages may be present on the inside of the Wallbox as well as on components you are able to touch
- Disregard of or actions contrary to the safety information and instructions contained in the comprehensive manuals and printed on the device may lead to electric shock, fire and/or severe injury
- Should you detect damage to the housing or charging cable, you must immediately discontinue installation of the Wallbox or take the already installed Wallbox out of operation via the upstream miniature circuit breaker in your domestic power supply and the internal RCCB. No further use of the Wallbox is permitted in this case

1. SAFETY INFORMATION



- This Wallbox represents the current state of technology and fulfills all current technical safety requirements, guidelines and standards



The following working steps must be carried out by a qualified specialist electrical contractor

- Installation
- Disassembly
- Modifying or taking the Wallbox out of operation
- Resolving malfunctions and errors

1. SAFETY INFORMATION

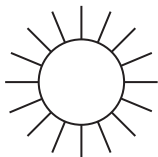

- The Wallbox is engineered for high ambient temperatures. It must always be ensured that the maximum operating temperature is not exceeded: p. 49
- Ideally, the installation site should be covered

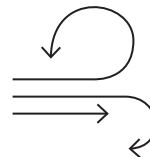

- The installation site must offer sufficient air circulation



- The installation site must not be located in explosive atmosphere areas



- The installation site
- is not located in areas subject to flooding or in close proximity to water
 - is not being used to store objects or containers containing liquids

1. SAFETY INFORMATION

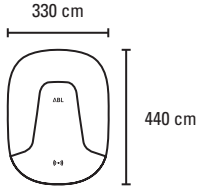

The mounting area

- measures 440 x 330 mm (H x W)
- must have an even and firm surface. The entire rear surface of the Wallbox must be in contact with the mounting surface

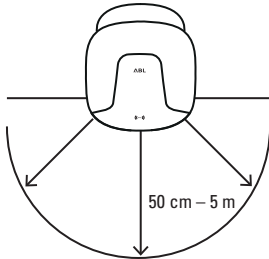

The installation site

- provides for a distance between 50 cm and 5 m to the vehicle
- is not located in a confined space and must be freely accessible

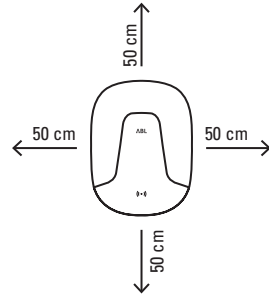

- A minimum distance to other technical installations of 50 cm must be observed
- Radio transmitters must be at least 20 cm away from the Wallbox

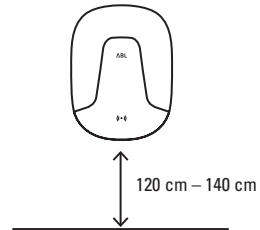

Installation height

- is 120 to 140 cm from the floor to the lower edge of the housing
- is located at elevations of max. 2,000 meters AMSL

1. SAFETY INFORMATION

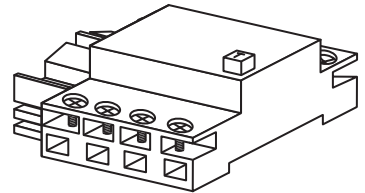
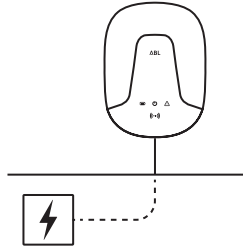

- All regulatory requirements for low voltage installations according to IEC 60364-1 and IEC 60364-5-52 apply
- The installation site must offer a sufficiently dimensioned power supply cable according to HD 60364-7-722:2012
- If necessary, a separate power supply must be installed that is intended exclusively for connecting the Wallbox and complies with the general requirements for cabling and building infrastructure
- The power supply cable may be installed above or below the wall surface
- Cable dimensions must be adjusted according to the prevailing conditions. The terminal blocks in the Wallbox are designed for cable dimensions from 1.5 mm² to 16 mm²

1. SAFETY INFORMATION

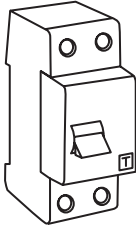

Your Wallbox features an internal Type A residual current circuit breaker and integrated DC fault current detection. The domestic power supply must

- be protected with a C-characteristic circuit breaker with no more than 32 A that is not followed by any other downstream electrical devices.
- always be connected to the protective earth conductor
- only be interrupted using the upstream circuit breaker and the internal residual current circuit breaker to disconnect the Wallbox completely from the power grid

The identification on the product label indicates whether the Wallbox is approved to be installed and operated in your country.

Always applicable are the relevant country-specific and local safety regulations

- for the circuit breaker, its overvoltage protection and tripping type
- for the electricity supply, its rated voltage and rated current
- for electrical installations
- of the electricity grid operator

Depending on the desired rated power, the installation of the Wallbox may need to be registered with and/or approved by the local electricity grid operator before it is taken into operation

1. SAFETY INFORMATION

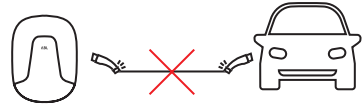
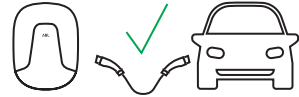
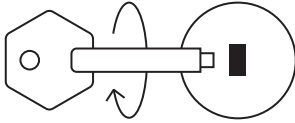

The housing cover of the Wallbox must be locked properly. Changes to, or the covering or taping up of the housing or the internal wiring

- represent a safety risk
- constitute a fundamental breach of the guarantee provisions
- may void the warranty with immediate effect

Only accessories intended for the Wallbox and supplied by the manufacturer must be used. The fixed charging cable of the Wallbox

- must not be extended with connectors, adapter cables or in any other way
- must not be under strain during charging operations

1. SAFETY INFORMATION

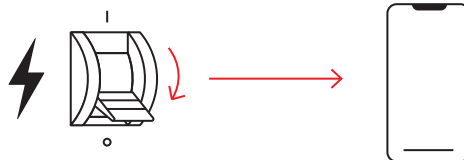

The Wallbox must be taken out of operation (see Operation Manual) and technical support (p. 69) must be contacted if

- the housing has been physically damaged
- the housing cover has been removed or can no longer be fixed to the housing
- it becomes obvious that sufficient protection against water and/ or foreign objects entering the device is no longer possible
- there is functional or visible damage to the fixed charging cable
- the Wallbox does not function properly or has been otherwise damaged
- Wallbox errors repeat or occur permanently

2. COMPONENTS INCLUDED

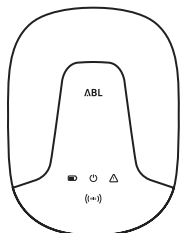

Wallbox

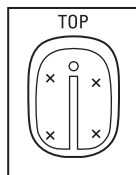

Drilling template

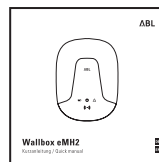

Quick start guide



2 x housing cover keys

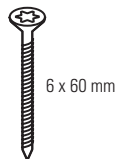

2 x 4 chipboard screws

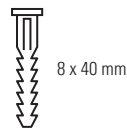

2 x 4 nylon wall plugs



- If components are missing, contact technical support: p. 69
- Keep the packaging in case the Wallbox needs to be transported

3. YOUR WALLBOX

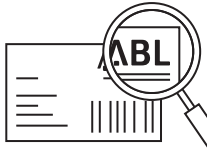

- 1** Identify the product number on the type plate. The type plate is located on the underside of the Wallbox
 - 2** Look up the technical data for your model variant: p. 49
- Sections marked with this symbol draw attention to further hazards that may lead to damage to the Wallbox itself or to other electrical devices
 - Actions marked with this symbol must be carried out with special care

3. YOUR WALLBOX

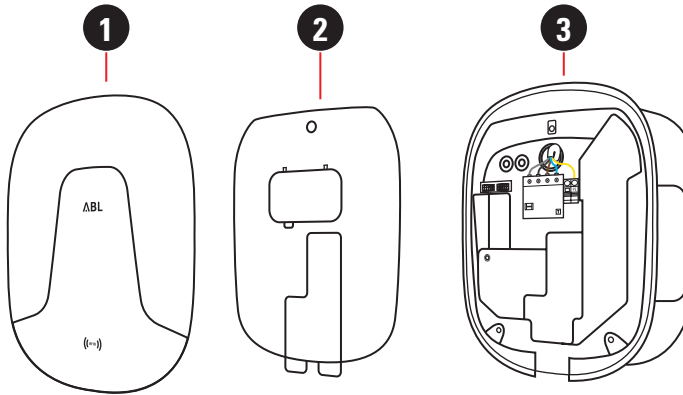

1 Housing cover

Detachable outer plastic cover to be fixed to the housing base using hanging lip (upper edge) and locked using lockable screw (lower edge)

2 Electronic components cover

Internal cover for electronic module with integrated flap for manual access to the RCCB (residual current circuit breaker)

3 Housing base

Base with integrated electronic module, fixed charging cable with Type 2 charging plug or Type 2 charging socket and charging plug storage holder

3. YOUR WALLBOX

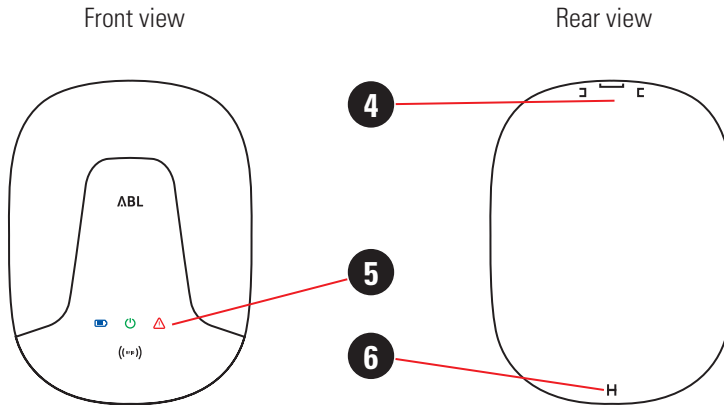

4 Plastic lip and guides

The plastic lip is for hanging the housing cover onto the housing base. The two guide pins ensure the correct vertical positioning of the housing cover

5 LED display

The multi-colored LED display is located in this part of the housing cover

6 Locking slot

The locking slot is for locking the housing cover to the housing base using the lockable screw

3. YOUR WALLBOX

Front view

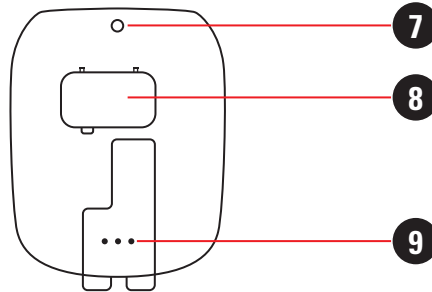

7 Opening for M4 fixing screw

This opening is used to fix the electronic components cover to the housing base with a fixing screw (M4 x 10)

8 RCCB access flap

This flap provides access to the RCCB inside the Wallbox

9 LED display lenses

The LED display is shown through these lenses

3. YOUR WALLBOX

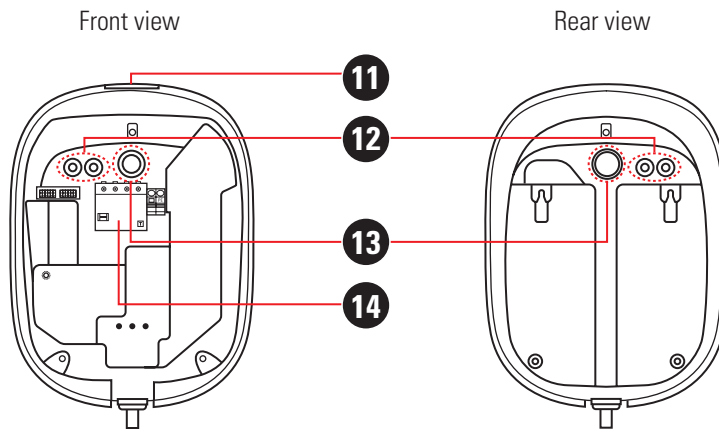

11 Housing cover slot

The plastic lip of the housing cover (4) is inserted into this slot

12 Grommets for data cables

These grommets seal the openings for data cables in the terminals area of the housing base

13 Power supply grommet

This grommet seals the opening for the power supply in the terminals area of the housing base

14 RCCB

The RCCB and the adjacent PE terminals are for connecting the power supply

3. YOUR WALLBOX

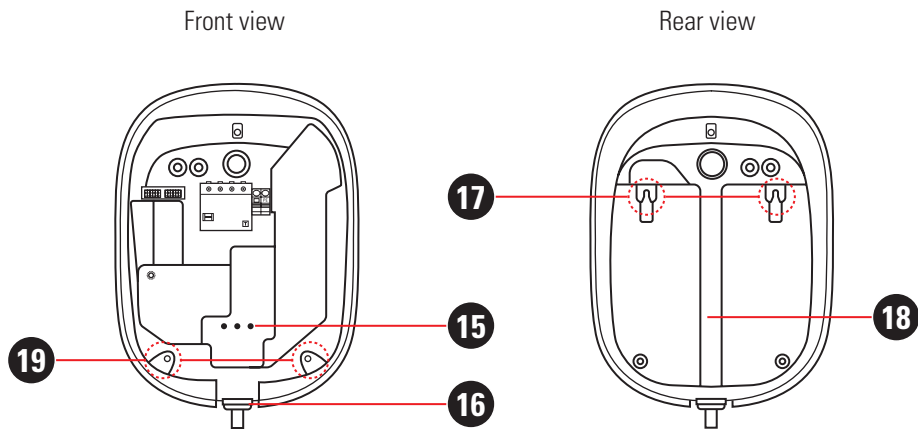

15 Opening for LED display

The LED display is shown through this opening

16 Lockable screw for housing cover

This lockable screw is for locking the housing cover. Its key is also included

17 Mounting screw slots

The housing base is fixed into position by hooking these two slots onto mounting screws

18 Cable guide

This cable guide is intended for a surface-mounted power supply cable

19 Openings for screw fixings

These openings are used to fix the housing base into position with two screws after it has been hooked onto the screw slots (17)

3. YOUR WALLBOX

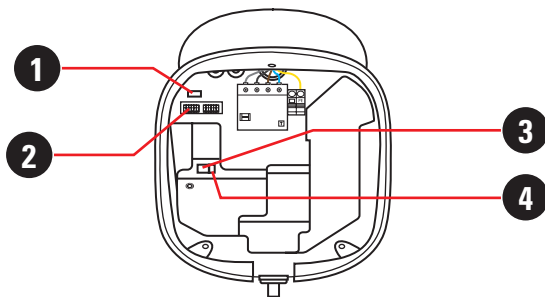

Interface	Purpose	Master+	Master	Slave+	Slave
1 USB dongle or RJ12 dongle	<ul style="list-style-type: none"> · Configuration · Charge control · RFID Master / Slave system	•	•	•	•
2 Daisy chain circuit board	<ul style="list-style-type: none"> · Energy meter configuration · Distribution · RS485 Bus control · RS485 energy meter Master / Slave system	•	•	•	•
3 Type A USB	<ul style="list-style-type: none"> · WIFI dongle · SBC configuration · Backend communication · LTE dongle · Backend communication 	•	•		
4 RJ45 ethernet	SBC configuration Backend communication	•	•		

3. YOUR WALLBOX

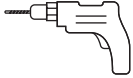

Electric drill

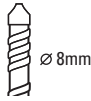

Drill bit

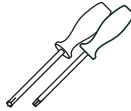

Screwdriver
Torx TX20, TX30
Phillips head



Pencil

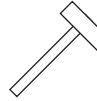

Hammer

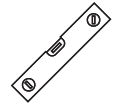

Spirit level

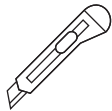

Utility knife



Voltmeter

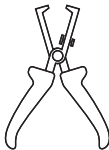

Wire stripper

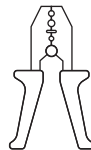

Crimp tool



Wire cutter



Data cable for
Master / Slave
system

Components included

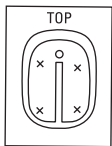

Drilling template



Housing cover key



6 x 60 mm

4 x chipboard screws



8 x 40 mm

4 x nylon wall plugs

4. PREPARATIONS



The five golden rules of electrical installation must always be observed

- 1.** Cut power source
- 2.** Secure all cut-off devices
- 3.** Verify absence of voltage
- 4.** Ground and short-circuit
- 5.** Cover or bar access to adjacent components under voltage



- Before installation, the circuit breaker for the Wallbox in the domestic power distribution must be switched off
- The circuit breaker must not be switched back on during installation.

5. MECHANICAL INSTALLATION

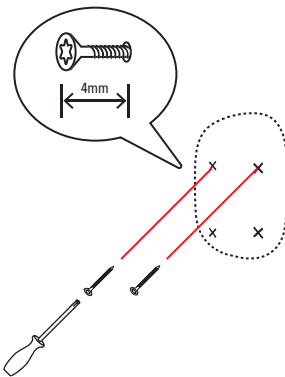
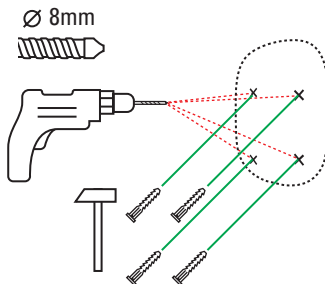
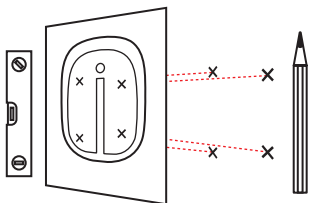

- 1** Cut the fixing points as marked on the drilling template
- 2** Place the drilling template vertically on the wall
- 3** Mark the four fixing points on the wall
- 4** Drill holes where the fixing points are marked. \varnothing 8 mm drill bit recommended
- 5** Insert the 8 x 40 mm nylon wall plugs into the mounting points
- 6** Insert one 6 x 60 mm chipboard screw into each of the two upper mounting points (using TX30). The distance between the head of the screw and the wall should be 4 mm

5. MECHANICAL INSTALLATION

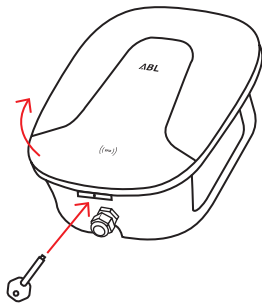

- 7** Open the lockable screw on the underside of the Wallbox by turning with the housing cover key approx. 4 times
- 8** Flip up the cover, remove it and keep it in a safe place

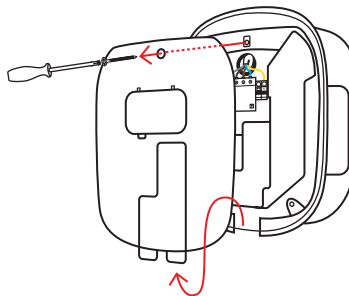

- 9** Remove the upper screw (M4 x 10 mm, TX20) of the electronic components cover and keep it in a safe place. Remove the electronic components cover and keep it in a safe place

5. MECHANICAL INSTALLATION

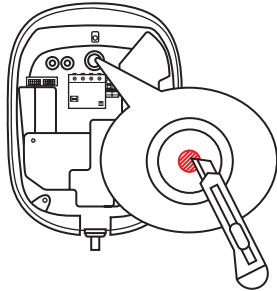

- 10** Cut an opening for the power supply cable into the membrane of the largest rubber grommet. The grommet is located in the upper part of the housing base

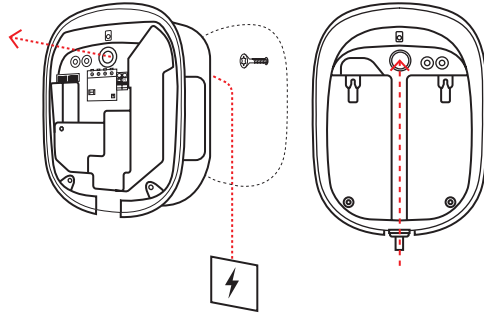

- 11** Insert the supply cable through the membrane opening

If the power supply cable is installed above-surface, a cable guide is provided at the back of the housing to guide the cable to the terminals area of the housing base

5. MECHANICAL INSTALLATION

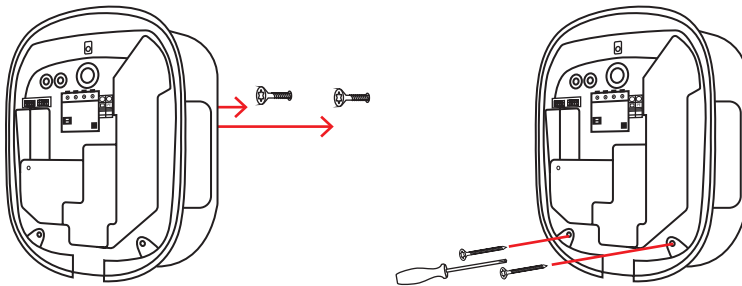

- 12** Hang the housing base onto the upper screws

The upper screw slots are located in the top part on the back of the housing base

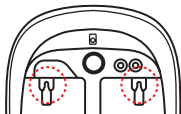

- 13** Insert two chipboard screws (6 x 60 mm, TX30) through the two lower openings in the housing base. Insert the screws into the lower mounting points and tighten

The lower openings are located in the bottom part of the housing base

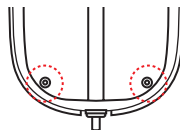

6. ELECTRICAL INSTALLATION

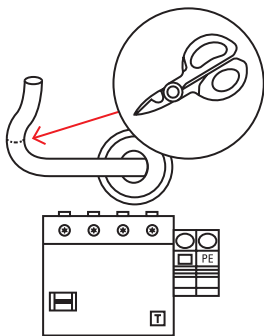

- 1** Cut the supply cable to the required length. Strip oversheath and screen to the required length

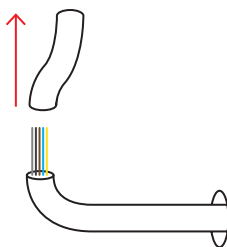

- 2** Strip oversheath and screen to the required length

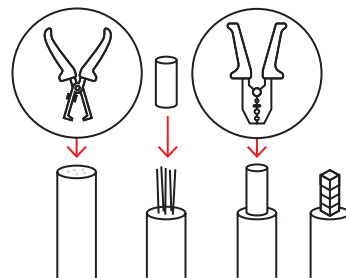

- 3** Strip the flexible wires and fit with wire end ferrules. A stripping length of 12 mm is recommended

6. ELECTRICAL INSTALLATION

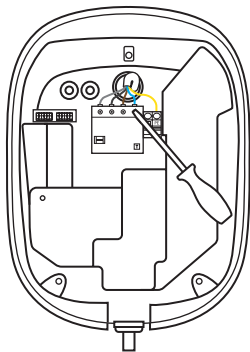

- 4** Loosen the terminal blocks of the RCCB
- 5** Insert wires into their respective terminals and tighten. A tightening torque of 2.5 to 3 Nm is recommended
- 6** The wiring sequence is shown in a table: p. 29

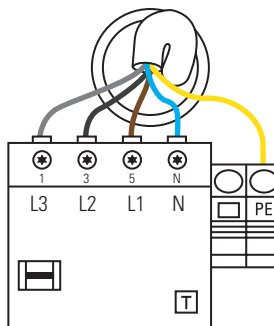

- 7** Ensure the correct position of the factory installed conductor at terminal L1
- 8** Operate the spring loaded mechanism of the PE terminal and attach the protective PE conductor

6. ELECTRICAL INSTALLATION

Designation	Conductor color	Connection coding	1-phase	3-phase
Phase 1 current-carrying conductor	Brown	5 – L1	•	•
Phase 2 current-carrying conductor	Black	3 – L2		•
Phase 3 current-carrying conductor	Gray	1 – L3		•
Neutral	Blue	N	•	•
Protective earth	Green-Yellow	PE	•	•



- The electronic components of your Wallbox will be damaged if a voltage above 250 V is applied between the L1 current-carrying conductor and neutral.
- The color-coding and the mains connection type given above are not internationally standardized

6. ELECTRICAL INSTALLATION

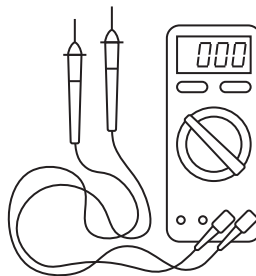
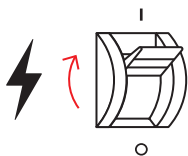

9 Switch on the circuit breaker in the domestic power distribution

10 Check the input voltage of the RCCB in the Wallbox and adjust it using the configuration tool if required: p. 42 ff.

6. ELECTRICAL INSTALLATION

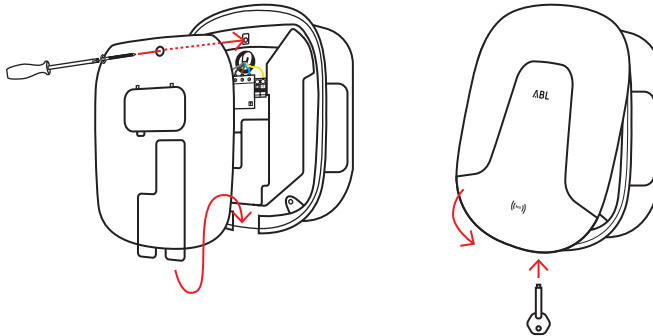

11 Replace the electronic components cover inside the housing base and fix it into place with its M4 x 10 - TX20 screw

12 Hang the housing cover onto the upper edge of the housing base. Tighten the lockable screw by turning with the housing cover key approx. 4 times

7. MASTER / SLAVE SYSTEM

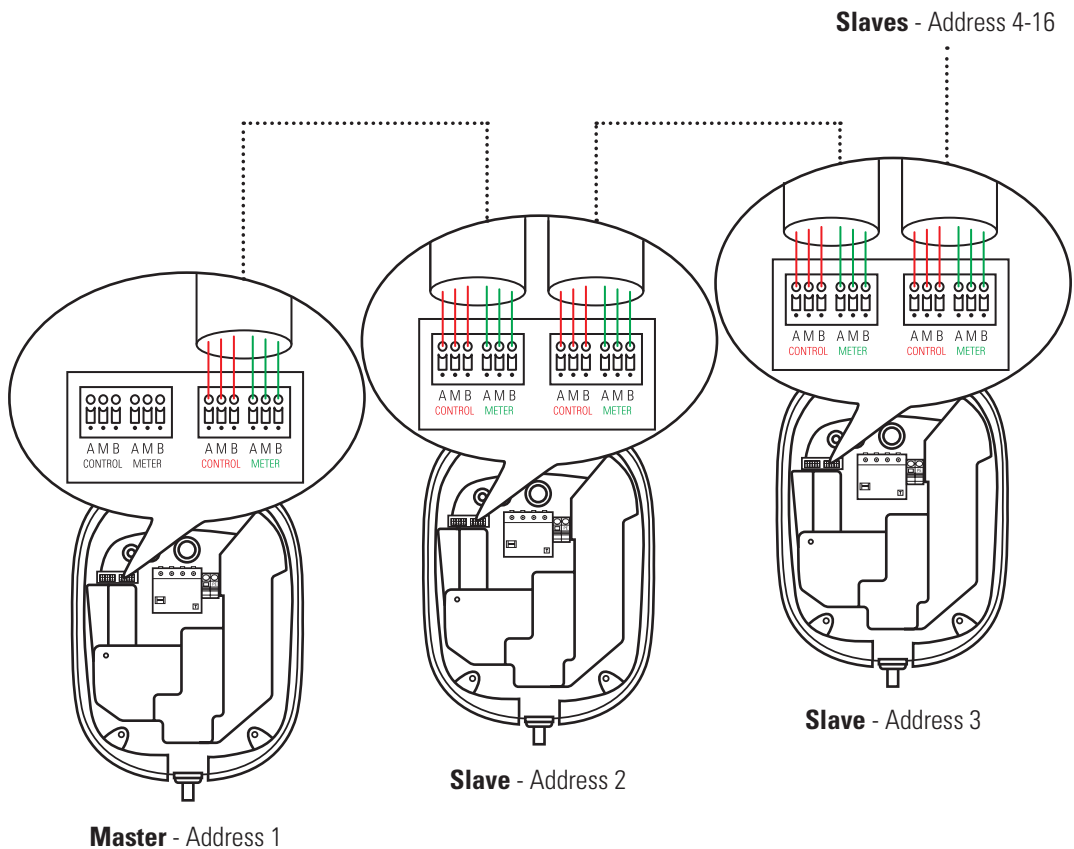

■ Connection energy meter
■ Connection EVCC

7. MASTER / SLAVE SYSTEM

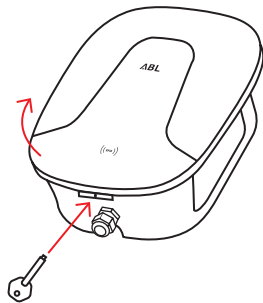

- 1** Open the lockable screw on the underside of the Wallbox by turning with the housing cover key approx. 4 times
- 2** Flip up the cover, remove it and keep it in a safe place

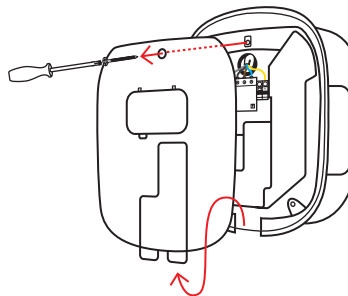

- 3** Remove the upper screw (M4 x 10 mm, TX20) of the electronic components cover and keep it in a safe place. Remove the electronic components cover and keep it in a safe place

7. MASTER / SLAVE SYSTEM

Master - Address 1

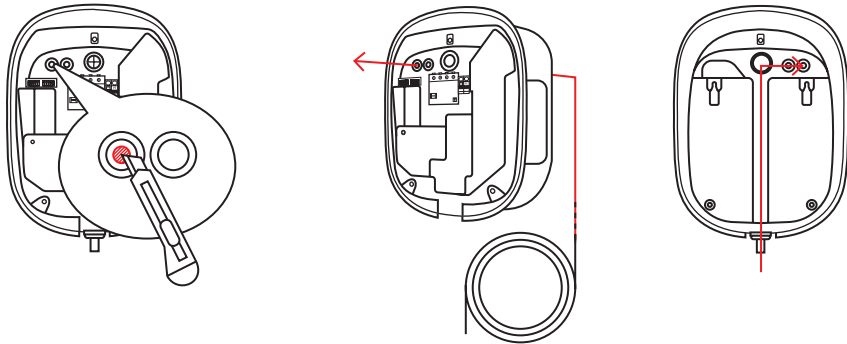

4 Cut openings for the data cables into one membrane of the two small rubber grommets. The grommets are located in the upper part of the housing base

5 Insert a suitable data cable through the membrane opening

If the power supply cable is installed above-surface, a cable guide is provided at the back of the housing to guide the cable to the terminals area of the housing

7. MASTER / SLAVE SYSTEM

Master - Address 1

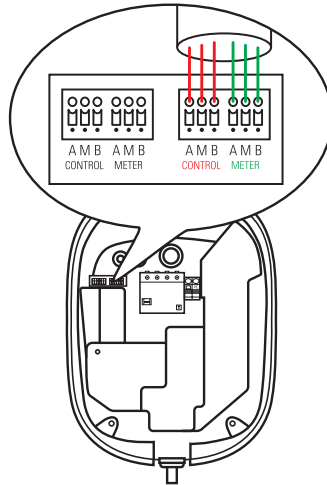

- 6 Connect the flexible wires with the terminal blocks „Meter“ and „Control“ of the Daisy Chain. The Daisy Chain is located in the upper part of the housing base



Abbreviation terminal blocks

Meaning

B	DATA
M	GND
A	DATA

7. MASTER / SLAVE SYSTEM

Slave - Address 2

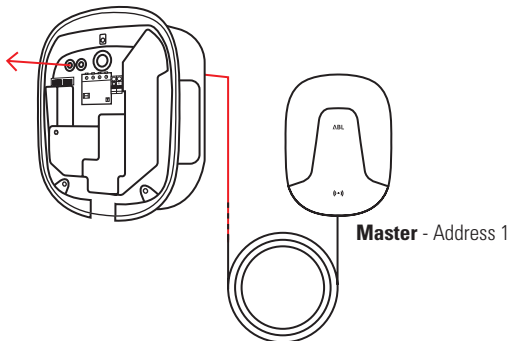
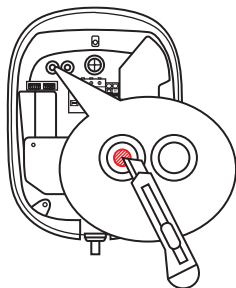

7 Cut openings for the data cables into one membrane of the two small rubber grommets

8 Insert the data cable through the membrane opening



One rubber grommet must be used either for the entry or exit of the data cable

7. MASTER / SLAVE SYSTEM

Slave - Address 2

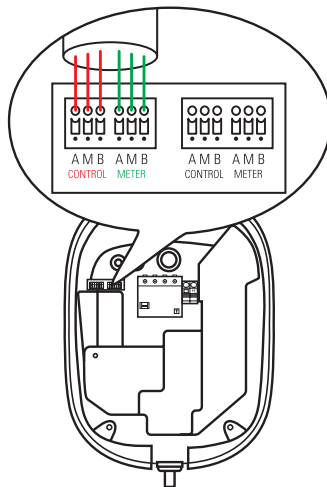

- 9 Connect the flexible wires with the terminal blocks „Meter“ and „Control“ of the Daisy Chain



Abbreviation terminal blocks Meaning

B	DATA
M	GND
A	DATA

7. MASTER / SLAVE SYSTEM

Slaves - Addresses 4-16

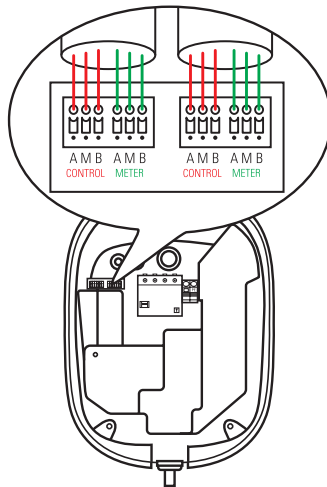

10 For further Wallboxes, follow the steps 1-9 in the same way

7. MASTER / SLAVE SYSTEM

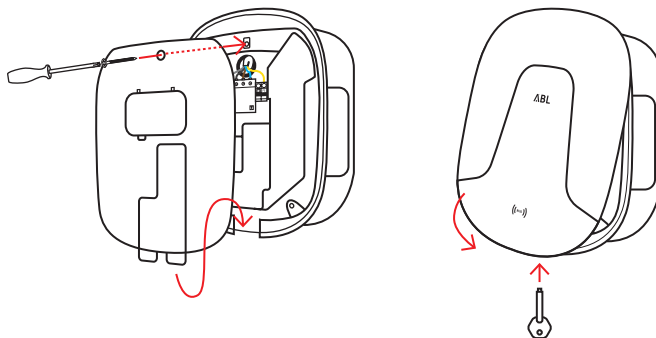

11 Replace the electronic components cover inside the housing base and fix it into place with its screw (M4 x 10 mm, TX20)

12 Hang the housing cover onto the upper edge of the housing base. Tighten the lockable screw by turning with the housing cover key approx. 4 times

8. TAKING INTO OPERATION

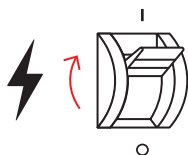

- 1** Switch on the circuit breaker in the domestic power distribution

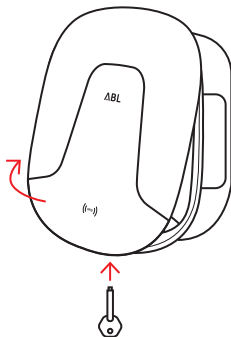

- 2** Open the lockable screw on the underside of the Wallbox by turning with the housing cover key approx. 4 times

- 3** Flip up the cover, remove it and keep it in a safe place

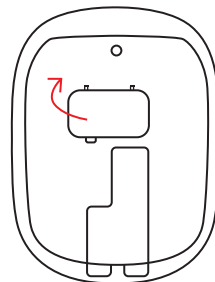

- 4** Open the access flap of the internal electronic components cover

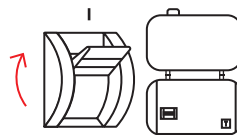

- 5** Switch on the RCCB in the Wallbox

8. TAKING INTO OPERATION

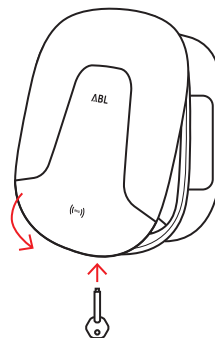
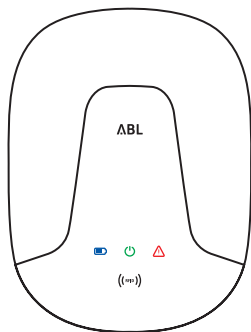

6 When the Wallbox is connected to the electricity grid, it will initiate the start-up procedure

7 The green LED pulsates. The Wallbox is ready for use

8 Hang the housing cover onto the upper edge of the housing base. Tighten the lockable screw by turning with the housing cover key approx. 4 times

9. CONFIGURATION



The following components can be configured

- EVCC
- RFID
- Energy meter

Depending on the request, the configuration is done via

- a) the Master: S. 44
- b) each Wallbox individually: S.45



The configuration tool is available to your qualified specialist electrical contractor

9. CONFIGURATION

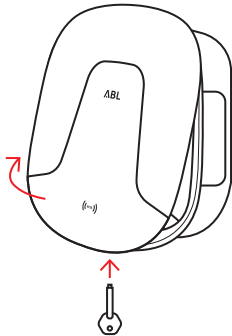

- 1** Open the lockable screw on the underside of the Wallbox by turning with the housing cover key approx. 4 times
- 2** Flip up the cover, remove it and keep it in a safe place

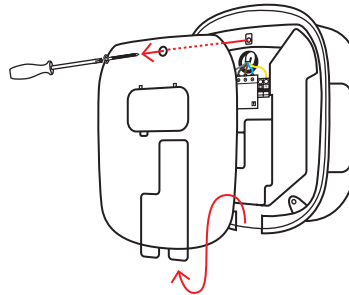

- 3** Remove the upper screw (M4 x 10mm, TX20) of the electronic components cover and keep it in a safe place. Remove the electronic components cover and keep it in a safe place

9. CONFIGURATION

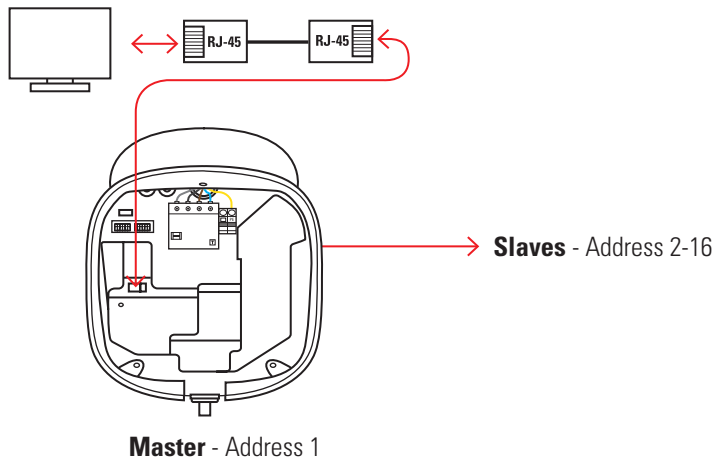

4 a) Connect a RJ-45 data cable with the RJ-45 adapter of the Master Wallbox. The RJ-45 adapter is located in the upper part of the housing base

5 a) Connect a RJ-45 data cable with the computer

7 a) Open the desired configuration tool

6 a) Turn on the Wallbox to be configured. Turn off the other Wallboxes

8 a) Configure the Wallbox



Before the configuration, the Wallboxes must be connected to each other: p. 32 ff.

9. CONFIGURATION

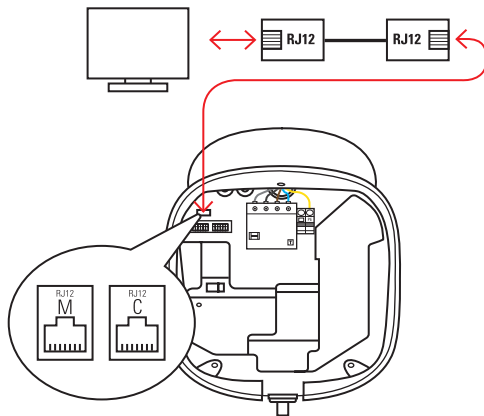

Master - Address 1

Slave - Address 2-16

- 4 b) Connect a RJ-12 data cable with the desired RJ-12 dangle of the Wallbox. The RJ-12 dangle is located in the upper part of the housing base
- 5 b) Connect a RJ-12 data cable with the computer
- 6 b) Open the desired configuration tool
- 7 b) Configure the Wallbox
- 8 b) For further Wallboxes, follow the steps 4.b) – 7.b) again



Abbreviation RJ-12 dangle	Meaning	Configuration
M	Meter	Energy meter
C	Control	· EVCC · RFID

9. CONFIGURATION

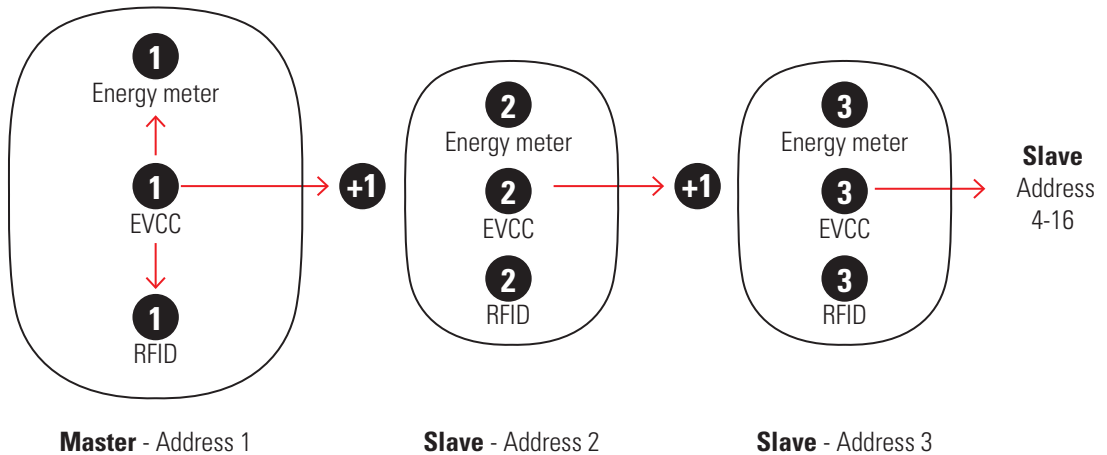

- The Master Wallboxes are factory preset to address 1. The Slave Wallboxes are factory preset to address 2
- Addresses of the same charge point must show identical values. The designation of each subsequent Wallbox must equal the value of the preceding one +1
- One Master can control up to 16 charge points

9. CONFIGURATION

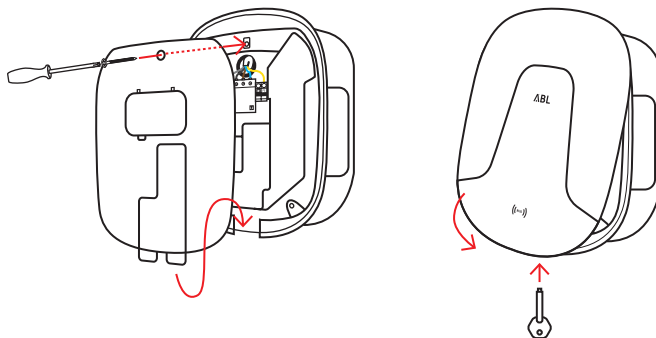

9 Replace the electronic components cover inside the housing base and fix it into place with its screw (M4 x 10mm, TX20)

10 Hang the housing cover onto the upper edge of the housing base. Tighten the lockable screw by turning with the housing cover key approx. 4 times

10. GLOSSARY

Abbreviation	Explanation	Meaning
Backend	Server-based application	Manages the measurement records
Daisy Chain	Electrical Bus System	Wiring scheme of several hardware components
DC fault current detection	DC residual current monitoring module	Detects and reports fault currents
Dongle	Copy protection	Interface
EVCC	Electric Vehicle Charge Controller	Charge controller
RCCB	Residual Current Circuit Breaker	Personal protection against electric shock
LED	Light Emitting Diode	Light source
Master	Coordinating charging station	Coordinates the Slave charging stations
AMSL	Above Mean Sea Level	Reference surface for heights above sea level
RFID	Radio-Frequency Identification	Wireless access control
SBC	Single Board Computer	Controls components of the charging point
Slave	Coordinated charging station	Forwards information to the Master charging station

11. TECHNICAL SPECIFICATIONS

Model number	2W2241	2W2231
Type	Master	Slave
Power supply	max. 5x16 ²	max. 5x16 ²
Rated voltage	230/400V	230/400V
Rated current	32A	32A
Rated frequency	50Hz	50Hz
Upstream fuse	MCB, C, max 32A	MCB, C, max 32A
Terminal block	Direct connection to RCD, PE to terminal block	Direct connection to RCD, PE to terminal block
Connection system	Charging cable with Type 2 connector in acc. with IEC62196-2, ca. 6 m	Charging cable with Type 2 connector in acc. with IEC62196-2, ca. 6 m
Max. output	22kW	22kW
AC fault current detection	RCD, Type A, 30mA	RCD, Type A, 30mA
DC fault current detection	electronic, 6mA	electronic, 6mA
Charge controller	EVCC2	EVCC2
Communication EV	IEC61851-1	IEC61851-1
Operating status indicator	LED	LED
Error display	LED	LED
Operating temperature	-30 to 40°C	-30 to 40°C
Storage temperature	-30 to 85°C	-30 to 85°C
Relative humidity	5 to 95% - no condensation	5 to 95% - no condensation
Class of protection	I	I
Degree of protection (housing)	IP44/IP54 (plugged/unplugged)	IP44/IP54 (plugged/unplugged)
Impact strength	IK08	IK08
Overvoltage category	III	III
Degree of pollution	3	3
Dimensions	437 x 328 x 170 mm	437 x 328 x 170 mm
Weight (net)	ca. 8,5 kg	ca. 8,5 kg
Weight (gross)	ca. 10 kg	ca. 10 kg

11. TECHNICAL SPECIFICATIONS

Model number	2W2261 / 2W22BK	2W2251 / 2W22BE
Type	Master +	Slave +
Power supply	max. 5x16 ²	max. 5x16 ²
Rated voltage	230/400V	230/400V
Rated current	32A	32A
Rated frequency	50Hz	50Hz
Upstream fuse	MCB, C, max 32A	MCB, C, max 32A
Terminal block	Direct connection to RCD, PE to terminal block	Direct connection to RCD, PE to terminal block
Connection system	Charging cable with Type 2 connector in acc. with IEC62196-2, ca. 6 m	Charging cable with Type 2 connector in acc. with IEC62196-2, ca. 6 m
Max. output	22kW	22kW
AC fault current detection	RCD, Type A, 30mA	RCD, Type A, 30mA
DC fault current detection	electronic, 6mA	electronic, 6mA
Charge controller	EVCC2	EVCC2
Communication EV	IEC61851-1	IEC61851-1
Operating status indicator	LED	LED
Error display	LED	LED
Operating temperature	-30 to 40°C	-30 to 40°C
Storage temperature	-30 to 85°C	-30 to 85°C
Relative humidity	5 to 95% - no condensation	5 to 95% - no condensation
Class of protection	I	I
Degree of protection (housing)	IP44/IP54 (plugged/unplugged)	IP44/IP54 (plugged/unplugged)
Impact strength	IK08	IK08
Overvoltage category	III	III
Degree of pollution	3	3
Dimensions	437 x 328 x 170 mm	437 x 328 x 170 mm
Weight (net)	ca. 8,5 kg	ca. 8,5 kg
Weight (gross)	ca. 10 kg	ca. 10 kg

11. TECHNICAL SPECIFICATIONS

Model number	2W2240	2W2230
Type	Master	Slave
Power supply	max. 5x16 ²	max. 5x16 ²
Rated voltage	230/400V	230/400V
Rated current	32A	32A
Rated frequency	50Hz	50Hz
Upstream fuse	MCB, C, max 32A	MCB, C, max 32A
Terminal block	Direct connection to RCD, PE to terminal block	Direct connection to RCD, PE to terminal block
Connection system	Type 2 charging socket in acc. with IEC62196-2	Type 2 charging socket in acc. with IEC62196-2
Max. output	22kW	22kW
AC fault current detection	RCD, Type A, 30mA	RCD, Type A, 30mA
DC fault current detection	electronic, 6mA	electronic, 6mA
Charge controller	EVCC2	EVCC2
Communication EV	IEC61851-1	IEC61851-1
Operating status indicator	LED	LED
Error display	LED	LED
Operating temperature	-30 to 40°C	-30 to 40°C
Storage temperature	-30 to 85°C	-30 to 85°C
Relative humidity	5 to 95% - no condensation	5 to 95% - no condensation
Class of protection	I	I
Degree of protection (housing)	IP54	IP54
Impact strength	IK08	IK08
Overvoltage category	III	III
Degree of pollution	3	3
Dimensions	437 x 328 x 170 mm	437 x 328 x 170 mm
Weight (net)	ca. 8,5 kg	ca. 8,5 kg
Weight (gross)	ca. 10 kg	ca. 10 kg

11. TECHNICAL SPECIFICATIONS

Model number	2W2260 / 2W22BH	2W2250 / 2W22BD
Type	Master +	Slave +
Power supply	max. 5x16 ²	max. 5x16 ²
Rated voltage	230/400V	230/400V
Rated current	32A	32A
Rated frequency	50Hz	50Hz
Upstream fuse	MCB, C, max 32A	MCB, C, max 32A
Terminal block	Direct connection to RCD, PE to terminal block	Direct connection to RCD, PE to terminal block
Connection system	Type 2 charging socket in acc. with IEC62196-2	Type 2 charging socket in acc. with IEC62196-2
Max. output	22kW	22kW
AC fault current detection	RCD, Type A, 30mA	RCD, Type A, 30mA
DC fault current detection	electronic, 6mA	electronic, 6mA
Charge controller	EVCC2	EVCC2
Communication EV	IEC61851-1	IEC61851-1
Operating status indicator	LED	LED
Error display	LED	LED
Operating temperature	-30 to 40°C	-30 to 40°C
Storage temperature	-30 to 85°C	-30 to 85°C
Relative humidity	5 to 95% - no condensation	5 to 95% - no condensation
Class of protection	I	I
Degree of protection (housing)	IP54	IP54
Impact strength	IK08	IK08
Overvoltage category	III	III
Degree of pollution	3	3
Dimensions	437 x 328 x 170 mm	437 x 328 x 170 mm
Weight (net)	ca. 8,5 kg	ca. 8,5 kg
Weight (gross)	ca. 10 kg	ca. 10 kg

11. TECHNICAL SPECIFICATIONS

Model number	2W7242	2W7240
Type	Master	Master
Power supply	max. 3x16 ²	max. 3x16 ²
Rated voltage	230V	230V
Rated current	32A	32A
Rated frequency	60Hz	50Hz
Upstream fuse	MCB, C, max 32A	MCB, C, max 32A
Terminal block	Direct connection to RCD, PE to terminal block	Direct connection to RCD, PE to terminal block
Connection system	Charging cable with Type 2 connector in acc. with IEC62196-2, ca. 6 m	Type 2 charging socket in acc. with IEC62196-2
Max. output	7.2kW	7.2kW
AC fault current detection	RCD, Type A, 30mA	RCD, Type A, 30mA
DC fault current detection	electronic, 6mA	electronic, 6mA
Charge controller	EVCC2	EVCC2
Communication EV	IEC61851-1	IEC61851-1
Operating status indicator	LED	LED
Error display	LED	LED
Operating temperature	-30 to 40°C	-30 to 40°C
Storage temperature	-30 to 85°C	-30 to 85°C
Relative humidity	5 to 95% - no condensation	5 to 95% - no condensation
Class of protection	I	I
Degree of protection (housing)	IP44/IP54 (plugged/unplugged)	IP54
Impact strength	IK08	IK08
Overvoltage category	III	III
Degree of pollution	3	3
Dimensions	437 x 328 x 170 mm	437 x 328 x 170 mm
Weight (net)	ca. 8,5 kg	ca. 8,5 kg
Weight (gross)	ca. 10 kg	ca. 10 kg

11. TECHNICAL SPECIFICATIONS

Model number	2W7244	2W7241
Type	Master	Master
Power supply	max. 3x16 ²	max. 3x16 ²
Rated voltage	230V	230V
Rated current	32A	32A
Rated frequency	50Hz	50Hz
Upstream fuse	MCB, C, max 32A	MCB, C, max 32A
Terminal block	Direct connection to RCD, PE to terminal block	Direct connection to RCD, PE to terminal block
Connection system	Charging cable with Type 1 connector in acc. with IEC62196-2, ca. 6 m	Charging cable with Type 2 connector in acc. with IEC62196-2, ca. 6 m
Max. output	7.2kW	7.2kW
AC fault current detection	RCD, Type A, 30mA	RCD, Type A, 30mA
DC fault current detection	electronic, 6mA	electronic, 6mA
Charge controller	EVCC2	EVCC2
Communication EV	IEC61851-1	IEC61851-1
Operating status indicator	LED	LED
Error display	LED	LED
Operating temperature	-30 to 40°C	-30 to 40°C
Storage temperature	-30 to 85°C	-30 to 85°C
Relative humidity	5 to 95% - no condensation	5 to 95% - no condensation
Class of protection	I	I
Degree of protection (housing)	IP44/IP54 (plugged/unplugged)	IP44/IP54 (plugged/unplugged)
Impact strength	IK08	IK08
Overvoltage category	III	III
Degree of pollution	3	3
Dimensions	437 x 328 x 170 mm	437 x 328 x 170 mm
Weight (net)	ca. 8,5 kg	ca. 8,5 kg
Weight (gross)	ca. 10 kg	ca. 10 kg

11. TECHNICAL SPECIFICATIONS

Model number	2W22D1	2W22D2
Type	Master	Slave
Power supply	max. 5x16 ²	max. 5x16 ²
Rated voltage	230/400V	230/400V
Rated current	30A	30A
Rated frequency	50Hz	50Hz
Upstream fuse	MCB, C, max 32A	MCB, C, max 32A
Terminal block	Direct connection to RCD, PE to terminal block	Direct connection to RCD, PE to terminal block
Connection system	Type 2 charging socket in acc. with IEC62196-2	Type 2 charging socket in acc. with IEC62196-2
Max. output	22kW	22kW
AC fault current detection	RCD, Type A, 30mA	RCD, Type A, 30mA
DC fault current detection	electronic, 6mA	electronic, 6mA
Charge controller	EVCC2	EVCC2
Communication EV	IEC61851-1	IEC61851-1
Operating status indicator	LED	LED
Error display	LED	LED
Operating temperature	-30 to 40°C	-30 to 40°C
Storage temperature	-30 to 85°C	-30 to 85°C
Relative humidity	5 to 95% - no condensation	5 to 95% - no condensation
Class of protection	I	I
Degree of protection (housing)	IP54	IP54
Impact strength	IK08	IK08
Overvoltage category	III	III
Degree of pollution	3	3
Dimensions	437 x 328 x 170 mm	437 x 328 x 170 mm
Weight (net)	ca. 8,5 kg	ca. 8,5 kg
Weight (gross)	ca. 10 kg	ca. 10 kg

11. TECHNICAL SPECIFICATIONS

Model number	2W22D3	2W72D1
Type	Master	Master
Power supply	max. 5x16 ²	max. 3x16 ²
Rated voltage	230/400V	230V
Rated current	30A	30A
Rated frequency	50Hz	50Hz
Upstream fuse	MCB, C, max 32A	MCB, C, max 32A
Terminal block	Direct connection to RCD, PE to terminal block	Direct connection to RCD, PE to terminal block
Connection system	Charging cable with Type 2 connector in acc. with IEC62196-2, ca. 6 m	Type 2 charging socket in acc. with IEC62196-2
Max. output	22kW	7.2kW
AC fault current detection	RCD, Type A, 30mA	RCD, Type A, 30mA
DC fault current detection	electronic, 6mA	electronic, 6mA
Charge controller	EVCC2	EVCC2
Communication EV	IEC61851-1	IEC61851-1
Operating status indicator	LED	LED
Error display	LED	LED
Operating temperature	-30 to 40°C	-30 to 40°C
Storage temperature	-30 to 85°C	-30 to 85°C
Relative humidity	5 to 95% - no condensation	5 to 95% - no condensation
Class of protection	I	I
Degree of protection (housing)	IP44/IP54 (plugged/unplugged)	IP54
Impact strength	IK08	IK08
Overvoltage category	III	III
Degree of pollution	3	3
Dimensions	437 x 328 x 170 mm	437 x 328 x 170 mm
Weight (net)	ca. 8,5 kg	ca. 8,5 kg
Weight (gross)	ca. 10 kg	ca. 10 kg

11. TECHNICAL SPECIFICATIONS

Model number	2W72D2
Type	Slave
Power supply	max. 3x16 ²
Rated voltage	230V
Rated current	30A
Rated frequency	50Hz
Upstream fuse	MCB, C, max 32A
Terminal block	Direct connection to RCD, PE to terminal block
Connection system	Type 2 charging socket in acc. with IEC62196-2
Max. output	7.2kW
AC fault current detection	RCD, Type A, 30mA
DC fault current detection	electronic, 6mA
Charge controller	EVCC2
Communication EV	IEC61851-1
Operating status indicator	LED
Error display	LED
Operating temperature	-30 to 40°C
Storage temperature	-30 to 85°C
Relative humidity	5 to 95% - no condensation
Class of protection	I
Degree of protection (housing)	IP54
Impact strength	IK08
Overvoltage category	III
Degree of pollution	3
Dimensions	437 x 328 x 170 mm
Weight (net)	ca. 8,5 kg
Weight (gross)	ca. 10 kg

12. DIMENSIONED DRAWING

WALLBOX eMH2 WITH CHARGING SOCKET

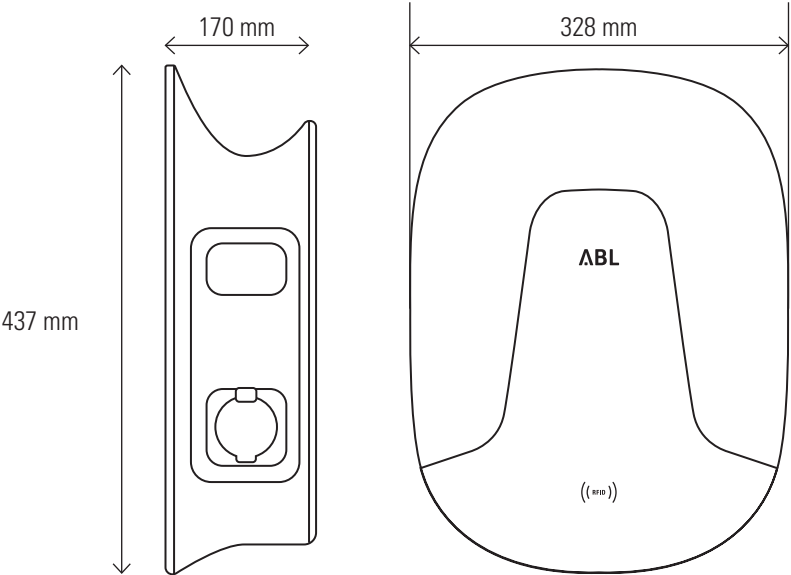

12. DIMENSIONED DRAWING

TYPE 2 CHARGING SOCKET

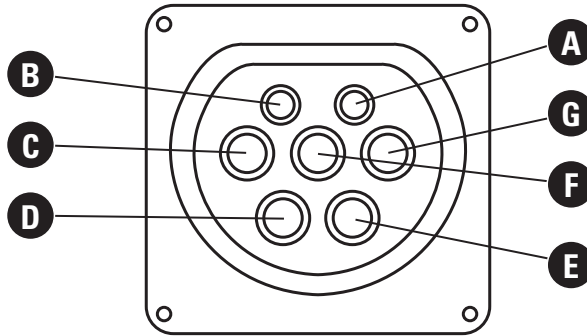

A CP - Control Pilot

B PP - Proximity Pilot

C L1 - Current-carrying conductor

D L2 - Current-carrying conductor

E L3 - Current-carrying conductor

F N - Neutral conductor

G PE - Protective Earth conductor

12. DIMENSIONED DRAWING

WALLBOX eMH2 WITH CHARGING CABLE

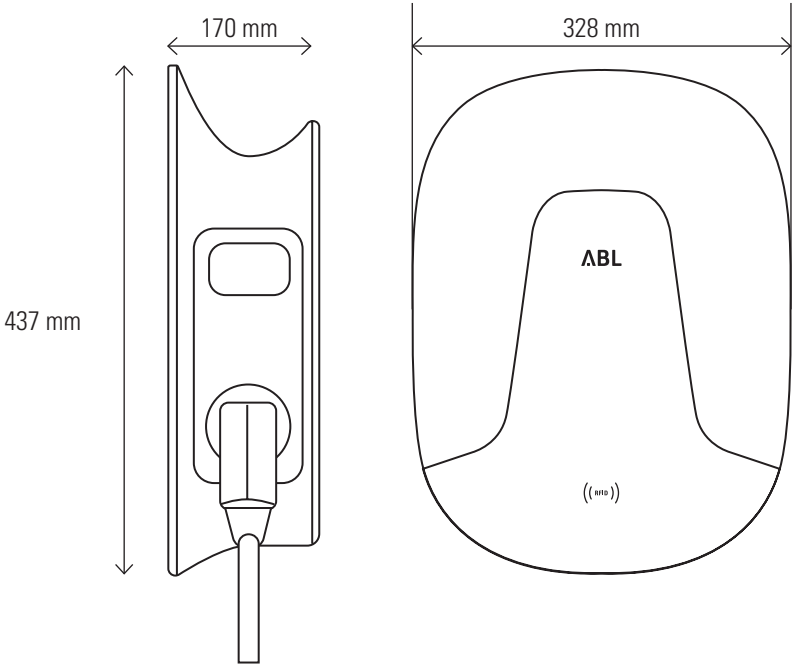

12. DIMENSIONED DRAWING

TYPE 1 CHARGING CABLE

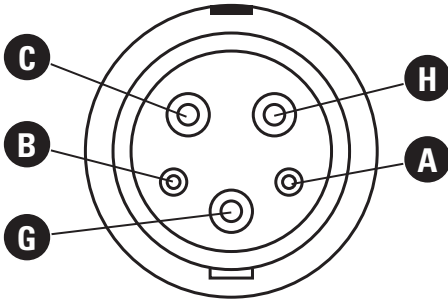

- A** CP - Control Pilot
- B** PP - Proximity Pilot
- C** L1 - Current-carrying conductor
- D** L2 - Current-carrying conductor

TYPE 2 CHARGING CABLE

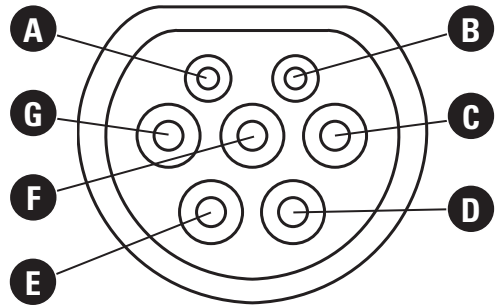

- E** L3 - Current-carrying conductor
- F** N - Neutral conductor
- G** PE - Protective Earth conductor
- H** L2 - Current-carrying conductor /
N - Neutral conductor

13. STANDARDS AND GUIDELINES

GENERAL GUIDELINES AND LAWS

2014/30/EU	EMC Directive
2014/35/EU	Low Voltage Directive
2011/65/EU	RoHS Directive
2012/19/EU	WEEE Directive
Electrical and Electronic Device Statute	

DEVICE SAFETY STANDARDS

IEC 61851-1: 2017 Ed. 3.0	Conductive charging systems for electric vehicles – Part 1: General requirements
IEC/TS 61439-7: 2014	Part 7: Assemblies for specific applications such as marinas, campgrounds, market squares, electric vehicle charging stations
IEC 61000-6-2:2016	Electromagnetic compatibility (EMC) - Part 6-2: Generic standards - immunity standard for industrial environments
IEC 61000-6-3:2006+AMD1:2010	Electromagnetic compatibility (EMC) - Part 6-3: Emission standard for residential, commercial and light-industrial environments
IEC 61000-6-7:2014	Electromagnetic compatibility (EMC) - Part 6-7: Generic standards - Immunity requirements for equipment intended to perform functions in a safety-related system (functional safety) in industrial locations
IEC 61851-21-2: 2018 Ed. 1.0	Conductive charging systems for electric vehicles - Part 21-2: EMC requirements for off-board charging systems for electric vehicles

14. CE CERTIFICATION AND COMPLIANCE DECLARATION



CE certification and compliance declaration

The eMH2 Wallbox carries the CE mark.

The associated compliance declaration is available for download at www.abl.de.

15. TRADEMARKS

All trademarks mentioned in this manual, including those that may be protected by third parties are, without restriction, subject to the regulations of the respectively applicable trademark law and the property rights of the respective registered owners.

All trademarks, trading names or company names marked here as such, are or may be trademarks or registered trademarks of their respective owners. All rights not explicitly granted here are reserved.

The absence of explicit identification of trademarks used in this manual must not lead to the conclusion that a name is free from the rights of third parties.

16. WARRANTY AND GUARANTEE PROVISIONS

For this product, ABL provides the legally prescribed guarantee period as well as a warranty of the same duration for the country in which the product was purchased. Should the product be operated in another country, the legal provisions of the country of purchase apply nevertheless: Under no circumstances are guarantees or the warranty transferable. Should modifications of any kind have been made to the product that have not been explicitly authorized by ABL or described in the guidelines for authorized service partners, the manufacturer's warranty obligations become void with immediate effect. Onsite repairs are expressly excluded by the manufacturer. In case of disregard of this provision, all guarantee and warranty provisions become void with immediate effect.



Should problems occur when operating your product, please contact your local distributor or authorized representative immediately and clarify whether the malfunction is covered by guarantee and/or warranty provisions. Do not under any circumstances make alterations or repairs to your product yourself!

16. WARRANTY AND GUARANTEE PROVISIONS

ABL guarantees the proper operation of this product after delivery within the applicable legal guarantee provisions. This guarantee is limited to damage that can be shown to have resulted from normal use, and obvious material or manufacturing defects. In such cases, the manufacturer, in collaboration with the local distributor, will attempt to restore the proper functioning of the product. The customer will be responsible for covering any arising transport costs. However, the manufacturer further rejects any damage claims that can be shown to have resulted from improper use, neglect or modifications, from repair attempts by unauthorized persons or force majeure. Any assumed guarantees, including a guarantee of marketability or suitability for specific uses are restricted to the warranty period.



Delegate the task of final installation to a qualified and authorized specialist contractor: In case of installation faults that can be traced back to improper mounting and installation, all guarantee and warranty provisions are void. Proof of proper installation (by way of presenting receipts or similar) may be required before warranty/guarantee provisions come into force.

17. INTELLECTUAL PROPERTY & COPYRIGHT

Copyright © 2019

Version Prod.Nr._Index status – 03-14-2019

All rights reserved.

Any information in this manual may be changed without prior notice and does not represent any obligation on the part of the manufacturer.

Illustrations in this manual may show designs different from the delivered product and do not represent any obligation on the part of the manufacturer.

The manufacturer does not take responsibility for any loss and/or damage that occurs because of the data or possible misinformation contained in this manual.

This manual, in its entirety or in parts, must not be reproduced, stored electronically or otherwise transmitted electronically, electrically, mechanically, optically, chemically, by photocopy or as an audio recording without the written permission of the manufacturer.

18. DISPOSAL ADVICE



For the preservation and protection of the environment, the prevention of pollution and in order to improve the recycling of resources, the European Commission has issued a guideline (WEEE-Guideline 2012/19/EC and EAG-VO) according to which electrical and electronic devices are taken back by the manufacturer in order to have them properly disposed of or recycled.

Therefore, devices marked with this symbol may not be disposed of as part of unsorted domestic waste inside the European Union: Please enquire with your local authorities regarding proper disposal.

The materials are recyclable as marked. By re-using, recycling or through other forms of processing obsolete devices, you make an important contribution to environmental protection.

CONTACT

ABL

Manufacturer

ABL Sursum
Bayerische Elektrozubehör GmbH & Co. KG

Albert-Büttner-Straße 11
91207 Lauf / Pegnitz

Germany

Phone +49(0)9123 188-0
Fax +49 (0)9123 188-188

Web www.abl.de
Email info@abl.de

Technical support

Phone +49(0)9123 188-600
Email support@abl.de



ABL

ABL SURSUM
Bayerische Elektrozubehör
GmbH & Co. KG

Albert-Büttner-Straße 11 · D-91207 Lauf / Pegnitz
Ph.: +49(0)9123 188-0 · Fax +49(0)9123 188-18
info@abl.de · www.abl.de